

Mission Statement

Oregon High School Equestrian Teams (OHSET) shall be a “not for profit” corporation dedicated to promoting and organizing equestrian competition in high school athletic or activity programs.

Oregon High School Equestrian Teams (OHSET) has as its main goal, recognition in the high schools of the equestrian athlete and to give them an opportunity to achieve that recognition in a fair, positive and educational format. The goals are to encourage team play, peer acceptance and good horsemanship. Competition is to follow sportsmanship guidelines as set down by Oregon School Activities Association (OSAA) State School Board, individual participating school activity guidelines and equine sportsmanship guidelines.

Any high school in the United States of America is eligible to form a team and join the OHSET organization. The state is divided into districts. District competitions will be held with the goal of qualifying for a final State Championship Meet to be held by the host district for that current year. Each high school will have adult and youth representation on their District Board of Directors. Each district will have adult and youth representatives on the State Board of Directors.

Competition is a winter/spring sport scheduled as much as possible not to conflict with other organized high school sports. The purpose is to promote continuous growth in programs fostering horsemanship education, sponsor activities to encourage interscholastic participation and to have cooperative adult supervised leadership for all students in grades 9-12.

High School Equestrian Teams support, challenge, and offer recognition to the dedicated teens that both physically and mentally, pursue the challenge of the sport of equine competition.

Table of Contents

Mission Statement	1
Constitution of By-Laws	4-15
General Rules	17-41
1. Rules	17
2. Insurance	18-19
3. Participation	19-26
3.1. General Participation	19-20
3.2. Team Participation in OHSET	20
3.3. Athlete Participation in OHSET	20-22
3.4. Athlete Participation in District Meets	23
3.5. Alternate Participation in OHSET	23
3.6. Combination Team Participation	23-24
3.7. Equine Participation in OHSET	25-26
4. Athlete Uniform	26-28
5. Tack & Equipment	29
6. The Season & Scheduling	29-30
7. Patterns	30
8. Judging	30-32
9. Cooperative Sponsorship	32-34
10. Scoring/Placing	35-36
11. Year End District Points	36-38
12. Awards	38-39
13. State Meet	39-41
14. Cattle Events	43-52
14.11. Re-Rides	44-46
14.12. Two Man Sorting	46-48
14.13. Placing	48
14.14. Breakaway Roping/Steer Daubing	48-51
Cattle Diagram	52
15. Dressage, Dressage Trail	54-55
16. Drill Team	56-60
17. Driving	61
18. Hunt Seat Equitation, Hunt Seat Trail	62-63
19. Hunt Seat Equitation Over Fences	64-65
20. In Hand Obstacle Relay (IHOR)	66-67
21. In Hand Trail	68
22. Reining	70-71
23. Saddle Seat Equitation, Saddle Seat Trail	72
24. Showmanship	73
25. Timed Events, General Rules	74-91

26.	Course Records	75-76
27.	Individual Timed Events	78-87
28.	Team Timed Events	88-91
29.	Team Versatility	92-95
30.	Western Horsemanship, Western Trail	96-97
31.	Working Pairs	98-99
32.	Working Rancher	100

Other supporting documents including Standard Operating Guidelines (SOG's) available on-line

By-Laws
Of
OREGON HIGH SCHOOL EQUESTRIAN TEAMS, INC.
An Oregon Non-Profit Organization

PREAMBLE

This Constitution is established to facilitate interscholastic competition, promote a sound program of educational enrichment value and encourage a cooperative, democratic process of fair and good horsemanship with a youth focus.

ARTICLE 1 - NAME

The name of this organization shall be the “Oregon High School Equestrian Teams, Inc.,” hereinafter referred to as “OHSET”.

ARTICLE II - PURPOSE

The purpose of this organization, as a public benefit corporation, is to promote continuous growth in programs fostering horsemanship education, sponsor activities to encourage interscholastic participation and to have cooperative adult supervised leadership for all students in grades 9 through 12 who desire to participate, regardless of race, creed or national origin and meet the association rules, constitution and bylaws. This organization is organized exclusively for educational purposes within the meaning of 501c3 of the Internal Revenue Code.

ARTICLE III - GOALS

1. Through association leadership and coaching, it is OHSET’s goal that OHSET athletes derive benefit as a result of participating in horsemanship education programs and interscholastic competition.
2. OHSET and its representatives will provide situations where each equestrian team member can be exposed to cooperative working experiences that lead to common group goals.
3. OHSET and its representatives will encourage and promote each OHSET athlete by providing opportunities to experience good leadership, fair play, good horsemanship, honesty, character, pride, and good sportsmanship.
4. OHSET and its representatives will provide, conduct and host equestrian interscholastic programs and events with discipline-appropriate instruction, coaching methods, rules, judging, and condition guidelines to ensure the health, safety and welfare of each participant and equine.
5. OHSET will maintain fundamental principles, including but not limited to the following:
 - a. Qualification for moving on to the state level competition shall be based on an athlete and/or team’s participation in a minimum number of competitions, with each athlete’s and/or team’s points accumulated to determine their eligibility in that class.
 - b. Judging is discipline appropriate, standardized, and based on the athlete’s horsemanship skill and/or time, as applicable. Each athlete and/or team shall be

judged one at a time, on the athlete's own merit, performing the identified element(s), for each class in the competition.

c. Student participation eligibility will be determined utilizing the OSAA guidelines for varsity sports, combined with the high school's criteria for participation in OSAA varsity sports; exceptions require OHSET State Board approval.

ARTICLE IV - MEMBERSHIPS

OHSET membership consists of:

- Registered athletes of each registered high school team
- Registered athletes of each registered high school team
- Advisor(s)/Coach(es) of each high school team
- Volunteers active at the Team, District, and State level

Section A. Athlete Membership: Students in grades 9 through 12 are eligible for membership in OHSET.

Section B. Adult Membership: Adult advisors, coaches, and their assistants, and any adult administrator or volunteer who is serving in any capacity. Coaches and/or advisors need only to submit team registration to District Secretary or State Registrar by the registration deadline.

Section C. Team Registration: All high schools with an OHSET team must have written confirmation utilizing the current OHSET registration form bearing the signature of a high school administrator, of (a) such high school's name for an OHSET team.

Section D. New Teams: Teams may apply in writing, utilizing the current OHSET registration form bearing the signature of a high school administrator, for membership in OHSET by fax, e-mail, or letter. Such application must be addressed to the OHSET District Secretary or designated District Registrar for approval and then forwarded by such secretary or registrar to the State Board Secretary or designated State Registrar.

Section E. Voluntary Withdrawal: Any individual or team may voluntarily withdraw from membership in OHSET at any time and for any reason, preferably in writing.

Section F. Reinstatement Following Voluntary Withdrawal: Any individual or team that wishes to be reinstated following voluntary withdrawal may be reinstated in accordance with the same procedures governing the admittance of new members or teams.

Section G. Involuntary Removal: A Team or individual may be removed involuntarily from OHSET for violating OHSET's Code of Conduct, involuntary removal requires a two-thirds (2/3) majority vote of the State Board of Directors.

Section H. Reinstatement Following Involuntary Removal: Individuals or teams may be reinstated following submission of a written letter of request to the State Board of Directors and a two-thirds (2/3) majority vote of the State Board of Directors.

ARTICLE V - STATE BOARD OF DIRECTORS

Section A. Leadership: The leadership and governance of OHSET is vested in its State Board of Directors ("State Board").

1. Eligibility. Any administrative person who serves OHSET in any capacity and is

- endorsed by State Board membership is eligible for membership on the State Board
2. Voting Members. Only one (1) adult voting member from a school may serve on the State Board at any time.
 3. The State Board shall consist of the following:

Non-Voting Officers - may vote if representing their district; chair or acting chair may vote in the case of a tie vote.

- Chair
- Vice Chair
- Secretary
- Treasurer

Non-Voting Committee Chairs - may vote if representing their district; chair or acting chair may vote in the case of a tie vote

- Judge's Chair
- Rules Chair
- Co-op Chair
- Others as Appointed

Voting Committee Members - representatives from each District

- Chairs/Vice Chair/Adult Representatives
- Athletes
- See Table Article VI - Voting #5

Section B. Purpose:

The purpose of the OHSET State Board is to support and promote the mission and goals of the OHSET program.

Section C. Duties: The State Board shall have general supervision and control of all of OHSET's business and activities, in accordance with the general policies of OHSET and shall communicate its actions and plans to all OHSET members. The State Board is authorized to expand OHSET funds and to authorize activities of the various OHSET Districts and Committees

Other duties of the State Board include:

1. Establishing and conducting the OHSET State Competition and other post-district meet events;
2. Advising OHSET Districts in establishing and conducting District Competitions and programs;
3. Establishing criteria for, conducting training of, and certifying OHSET judges;
4. Informing and communicating with members and representatives about OHSET activities and opportunities;
5. Recognizing OHSET athletes and representatives;
6. Assuring OHSET offers its program and materials equally to all adult volunteers and appropriately aged youth in the State of Oregon;
7. Establishing and publishing rules for all levels of OHSET competition;
8. Amending OHSET's Bylaws as necessary to carry out the provisions of its Articles of

Incorporation;

9. Establishing and revising OHSET Districts and their boundaries.

Section D: Terms of Office:

1. Unless terminated as provided herein, the term of office for each District Chair, Youth District Representative and the Adult District Representative(s) on the State Board shall be one (1) year.
2. Each District Representative's term on the State Board begins at the June State Board meeting. Unless terminated as provided herein, the term of office for each State Board member concludes at the start of the following year's June meeting.

Section E. Termination:

1. For Cause: Any member of the State Board may be terminated for cause, including:
 - a. Absence from two (2) consecutive, regularly scheduled meetings, unless excused by the State Chair;
 - b. Violations of the OHSET Bylaws, Rules, and/or Code of Conduct;
 - c. Misappropriation of OHSET funds;
 - d. Any crime "on people" or other crime deemed unbecoming of OHSET by the State Board;
2. Procedure for termination with cause:
 - a. There must be a two-thirds (2/3) majority vote of the State Board in order to terminate a board member for cause;
 - b. Following a successful vote to terminate, a written letter will be delivered to the affected board member;
 - c. Terminated board members may apply to return to the State Board after the current season and two (2) additional completed seasons;
 - d. Terminated board members must also relinquish all District Board responsibilities;
3. Resignation: Any member of the State Board may resign upon written notice to the State Chair by mail or e-mail.
4. Vacancy:
 - a. If a vacancy occurs within the District Representatives of the State Board, the home District of the vacated member will elect a replacement to fill such vacancy. The newly elected member will serve the remainder of the vacated member's term.
 - b. If the vacancy is an officer or committee chair, they will be replaced as set forth in these Bylaws, in the section regarding "Board of Directors, Officer Duties".

ARTICLE VI - VOTING

Section A: State Board: The voting membership of the State Board consists of:

1. The District Chair from each District
2. One (1) Youth Representative from each District
3. One additional adult District Representative (if applicable-see #5 in following chart)

4. All of the above to be elected by the District prior to the June State Board meeting.
- 5.

# Of Districts	1-5	6-9	10+
# Of Adult Representatives	DC + 2 Adult Representatives	DC + 1 Adult Representative	DC Only

Section B: District Board: The voting membership of each District Board consists of:

1. One (1) coach/advisor or adult representative from each team within such district;
2. One (1) youth representative from each team within such District
3. Teams may vote only if they are registered with their school as a team for the current season, and have one or more 8th-12th grade students signed up. Teams that participated in the immediately preceding season, have until December 31st of the current season to register at least one 8th-12th grade student.

Section C: Process:

1. Effect of Withdrawal - At the State or District Level: Unless and until reinstated as provided herein, any individual or team voluntarily withdrawing from OHSET shall not be eligible to vote regarding any OHSET business immediately upon notification of such individual or team's withdrawal has been reported to the OHSET District Board of Directors or Chair.
2. A voting member shall cast one (1) vote at the State Board, District Board, or Team Meeting level. One (1) vote per member. Proxy voting is not allowed.
3. Voting at the team meetings:
 - 3.1 Voting at team meetings will be done by the registered student athletes (8th-12th grade) on the team. The Team Advisor may vote in the case of a tie vote.
 - 3.2 Delegation of votes is not permitted. Otherwise, all requirements for meetings, quorums, voting, decision making, and meeting notifications listed in Article VI Voting and Article VII meetings also apply to Team Meetings.
4. Unless otherwise provided herein, all official decisions, proposals and rule changes shall be by a simple majority of the voting members present at the meeting where such members cast their votes and a quorum exists.
5. A quorum shall be a minimum of one-third (1/3) of the total voting members of the board at any properly called meeting.
6. A voting member unable to attend a meeting must notify the Chair, Vice-Chair or Recording Secretary prior to the beginning of the meeting who will take their place as a voting representative. If that voting member is not able to make the proper notification, then that voting member's team advisor (for District Meetings) or District Chair (for State Meetings) may name the replacement voting member for that meeting.
7. Delegation of votes shall be restricted to members identified at the beginning of the meeting representing their team or district and logged into the meeting minutes.

ARTICLE VII - MEETINGS

Section A. Annual Meeting: The annual State Board meeting will be held between December 1st and February 1st, with at least thirty (30) days notice through the following communication methods:

1. E-mail to District Chairs and Vice Chairs
2. Posted on the Public OHSET Website

Section B. Special Meetings: Special meetings of any board, District or State, may be called at any time upon written request as follows:

1. By at least three (3) voting members of such board if:
 - a. The members requesting a District special meeting are from three (3) different teams within such District, and
 - b. The members requesting a State Special meeting are from three (3) different Districts.
2. Twenty-Five percent (25%) of the documented general membership (of district for district meeting or State for State Meeting) may call a special meeting of the District or State Board of Directors by notifying any board member.
3. A special meeting may be called of the District or the State Board of Directors by notifying the appropriate Chair or Vice Chair a minimum of fifteen (15) days prior to the meeting unless there is an extreme emergency.
 - a. This notification shall be made by e-mail with a request of an RSVP response. If no response within 48 hours,
 - b. A certified letter must be sent to the address on file with the appropriate Board

Section C. Board Meetings: State Board and District Board meetings may be called by their applicable Chair at any time and at such location as designated by the Board of Directors.

1. Each Board shall meet as such Board determines is necessary and appropriate
2. All State Board and District Board meetings are open to all OHSET members
3. Members should have at least three (3) days notice prior to such meetings

Section D. Alternate Venue

1. Any OHSET meeting (State/District board meeting, team meeting, special meeting, annual general meeting, committee meeting, training meetings, etc.) may be held electronically via phone or video conferencing.
2. All requirements for meetings, quorums, voting, decision making, delegation of votes and meeting notifications listed in Article VI Voting and Article VII meetings also apply to electronic meetings.
3. Electronic Meetings may not be held through time-delayed medium, such as e-mail.
4. Meetings held by telephone or video conference are a fully valid meeting, with the same legal effect as a meeting held in person. Minutes of telephone or video conference meetings should be taken and retained in the same manner as minutes of in person meetings. Minutes should reflect all actions taken by the board or membership during a meeting.

Section E. Committee Meetings: The Chair of each committee or the State Chair will call for committee meetings whenever and as often as such Chair deems necessary to execute the responsibilities of such committee. A progress report of each meeting shall be submitted to the applicable District Board and/or State Board at their next scheduled meeting.

ARTICLE VIII - OFFICERS

OHSET's corporate officers shall be:

- Chair
- Vice Chair
- Secretary
- Treasurer

1. The term of all officers is one (1) year and all may be re-elected without limit.
2. The State Board will elect its Chair and Vice Chair and confirm Chair appointments for Secretary and Treasurer, all of whom must be selected from the Board or any administrative person that serves in any capacity and is endorsed by State Board membership.
3. The State Chair may appoint committees as necessary.
4. The Chair and Vice Chair shall be elected by the voting members of the State Board present at the June State Board meeting.
5. The officers of the State Board shall assume their duties for the upcoming term immediately upon conclusion of the June State Board meetings.

Exception: Officers of the current year season who are involved in, or have responsibilities in, any regional or national competitions of the same season, will continue in their position until the completion of such competition.

Section A. State Chair: The State Chair is elected by the State Board and shall prepare the agenda for and preside at all meetings of the State Board and act as the Chief Executive Officer of OHSET.

1. The Chair shall vote only in the case of a tie.
2. The Chair shall be a member ex-officio of all regular and special committees and shall appoint Chairs of committees as needed;
3. They may also appoint additional non-voting Board members who perform delegated duties such as registrar, points, scholarship, etc.
4. And shall perform all other duties as usually pertain to the office.

Section B. State Vice-Chair: The Vice Chair is elected by the State Board and shall assist the Chair in the performance of their duties, including preparing the agenda for and presiding at meetings in the Chair's absence or at the Chair's request.

1. The Vice-Chair is a non-voting member of the State Board except when they are acting as the Chair in the case of a tie, or if Vice-Chair is simultaneously serving as a District Chair or District Representative.
2. The Vice Chair assumes temporary responsibilities of any vacated officer's post until the vacated post is filled and performs all other duties as usually pertain to the office.

Section C. State Secretary: The Secretary is appointed by the Chair and approved by the Board. The Secretary is a non-voting member of the State Board, although is eligible to vote if simultaneously serving as a District Chair or Representative. Secretary duties may not be split and partially delegated by the state chair.

Secretary duties include:

1. Create and keep record of all the meetings of the members and State Board and distribute meeting minutes via e-mail to all State Board members;
2. Have the custody of OHSET State Board meeting minutes;
3. Maintain a current list of all OHSET schools and total number of athletes at each and distribute annually to the State Board;
4. Maintain an accurate record of OHSET State Champions and other pertinent information for OHSET;
5. Performs all other duties as usually pertain to this office

Section D. State Treasurer: The State Treasurer is appointed by the Chair and approved by the Board. The Treasurer is a non-voting member of the State Board, although is eligible to vote if simultaneously serving as a District Representative.

1. The Treasurer shall have charge of all funds of OHSET and shall place the same in such bank or banks as may be approved by the State Board. Treasurer is not a signor on any OHSET bank account. Money shall only be withdrawn by the State Chair or second delegated signatory (usually the Vice Chair), and for the payment of only such debts previously budgeted or as approved by the State Board.
2. The Treasurer shall receive all contributions and keep an accurate accounting of all OHSET assets, liabilities, income and disbursements and render a detailed report at any meeting of the State Board, when requested, and an annual report to the members of OHSET at its annual meeting.
3. The Treasurer shall submit biannual financial statements to the State Board.
4. The Treasurer shall arrange for an independent financial review of OHSET financial records, such review shall be completed before installment of new State officers or appointment of a new Treasurer.
5. The Treasurer shall facilitate the filing of OHSET's annual tax return.

Section E. District Officers: At a minimum, each District Board shall consist of a Chair, Vice Chair, Secretary, Treasurer, a Youth Representative, and Adult Representative from participating schools.

1. The District Chair, Vice Chair, Adult and Youth representatives are elected by the district.
2. The Secretary and Treasurer are appointed by the District Chair and approved by the District Board.
3. The District Chair, Youth Representative and Adult Representative(s) shall be ready to report as the voting District Representatives to the June State Board meeting.
4. District Officer positions, cannot be held by more than one (1) person in the same immediate family.

Section F. Executive Administrator/Director: An Executive Administrator/Director may or may not be utilized by the State Board. If utilized, the Executive must be contracted. The Executive duties must be passed by a two-third (2/3) majority vote of the State Board and will be specifically outlined by a Board approved Standard Operating Guideline and a detailed contract with the Executive.

ARTICLE IX - STANDING COMMITTEE CHAIRS

Section A: Judges' Chair; will be appointed by the state Chair

1. The duties shall include developing all Standard Operating Guidelines and procedures related to judges of OHSET competitions.
2. Judge's Chair shall facilitate a judges' committee as the need arises, including pattern development.
3. Judges' Chair shall facilitate annual OHSET judges' training
4. All Standard Operating Guidelines developed for this committee and chair shall be approved by the State Board.

Section B: Rules Chair: will be appointed by the State Chair.

1. The Rules Chair's duties shall include facilitating rule changes, and the printing of the rule book and/or other rule documentations.
2. Rules Chair shall facilitate a rules committee as the need arises, including during the "rule change" process.
3. All Standard Operating Guidelines developed for this committee and chair shall be approved by the State Board.

ARTICLE X - AMENDMENTS

1. Proposed amendments must be submitted in writing with page number, article or section, one hundred twenty (120) days prior to the annual meeting to the State Chair or designee.
2. To be distributed to the membership sixty (60) days prior to the annual meeting via e-mail or first class mail.
3. District feedback should be received by the State Chair or designee thirty (30) days prior to the annual meeting.
4. Final draft changes must be shared with District Chairs and members at least two (2) weeks prior to the annual meeting
5. Bylaws shall be amended upon a vote of two-thirds (2/3) of the voting members of the State Board.
6. Bylaws may only be amended at the annual State Board meeting and are effective immediately.

ARTICLE XI - OFFICER LIMITATION OF LIABILITY; INDEMNIFICATION AND ADVANCEMENT OF EXPENSES IN CONNECTION WITH LITIGATION

An officer of OHSET who serves OHSET without compensation for personal services as an officer shall be considered a "qualified director" within the meaning of that term as used in these Bylaws. An uncompensated officer of OHSET shall be entitled to indemnification and advancement of litigation-related expenses to the same extent as a qualified Director. An

officer of OHSET who receives compensation for personal services to the Corporation shall receive such indemnity, limitation of liability, and advancement of suit related expenses as shall be consistent with the laws of the State of Oregon, these Bylaws, and the extent the State Board, in its sole discretion, determines such limitations on liability, indemnification, advancement of expenses, or any combination thereof, to be reasonable.

ARTICLE XII - AUTHORITY TO INDEMNIFY DIRECTORS; ADVANCEMENT OF EXPENSES FOR DIRECTORS

If any State Board member of OHSET is made a party to a proceeding because that individual is or was director, OHSET shall indemnify that individual against liability or damages to the full extent provided by ORS 65.391, 65.394, and 65.404, as amended. It shall be proper for OHSET to pay or reimburse reasonable expenses incurred by any State Board member who is a party to a proceeding, in advance of final disposition in that proceeding, if the State Board so authorizes and the State Board member complies with the provisions of ORS 65.398, as amended.

ARTICLE XIII - LIABILITY OF QUALIFIED DIRECTORS

Civil liability of a qualified Director of OHSET for the negligent performance of duties shall be limited to acts of gross negligence, intentional acts, or both and shall also be limited by any limitation on monetary damages set forth in the Articles of Incorporation. The term “qualified Director”, as used in these Bylaws, means a person who serves as a Director without compensation for personal services as director. An otherwise qualified Director shall not be considered to be compensated if the Director receives payments only for actual expenses incurred in attending meetings or performing Director’s duties or receives a stipend which is paid only to compensate the Director for average expenses incurred over the course of a year.

ARTICLE XIV - INDEMNIFICATION OF EMPLOYEES AND AGENTS

In its sole discretion, by general or specific action, the State Board may indemnify and advance expenses to any employee or agent of OHSET to the extent allowed by applicable law.

ARTICLE XV - GENERAL STANDARDS FOR DIRECTOR CONDUCT

Directors shall discharge their duties as a member of any committee:

- a. In good faith;
- b. With the care an ordinary prudent person in a like position would exercise under similar circumstances; and
- c. In a manner the Director reasonably believes to be in the best interest of OHSET.

In discharging the duties of a Director, a Director is entitled to rely on information, opinions, reports, or statements, including financial statements and other financial data, if prepared or presented by:

1. One (1) or more officers or employees of OHSET whom the Director reasonably believes to be reliable and competent in the matters presented
2. Legal counsel, public accountants, or other persons as to matters the Director reasonably believes are within the person’s professional or expert competence; and
3. A committee of which the director is not a member as to matters with its jurisdiction, if the Director reasonably believes the committee merits confidence.

A Director is not acting in good faith if the Director has knowledge concerning the matter in question that makes reliance otherwise permitted unwarranted. A Director is not liable to OHSET, any member, or any other person for any action taken or not taken as a Director, if the Director acted in compliance with this section. In addition, even if so liable, the Director's liability for monetary damages shall be limited as stated in the Articles of Incorporation. A Director shall not be deemed to be a trustee with respect to OHSET or with respect to any property held or administered by OHSET including without limit, property that may be subject to restrictions imposed by the donor or transfer of such property.

ARTICLE XVI - ASSETS DEDICATED TO AN EXEMPT PURPOSE

No substantial part of the activities of the organization shall be the carrying on of propaganda, or otherwise attempting to influence legislation and the organization shall not participate in, or intervene in any political campaign on behalf of any candidate for public office.

Notwithstanding any other provision of this document, the organization shall not carry on any other activities not permitted to be carried on:

1. By an organization exempt from federal income tax under section 501c3 of the Internal Revenue Code, or the corresponding section of any future federal code, or
2. By an organization, contributions to which are deductible under section 170c2 of the Internal Revenue Code, or the corresponding section of any future federal tax code.

ARTICLE XVII - DISTRIBUTION OF ASSETS

All funds obtained by OHSET shall be expended at the discretion of the State Board for the benefit of the existing and future Oregon High School Equestrian Teams. No funds will be expended for the personal gain of any inure to the benefit of, or be distributable to its members, directors, officers, or other private person, except that OHSET shall be authorized and empowered to pay reasonable compensation for services rendered and to make payments and distributions in furtherance of the purposes set forth in the purpose clause hereof.

In the event of OHSET's dissolution, all funds not specifically earmarked for approved expenditure will be given to the Oregon Equestrian Special Olympics, if no operating Oregon organization exists, funds would then go to the National Equestrian Special Olympics organization. However, if neither of these recipients is in existence or is no longer a qualified recipient, or unwilling or unable to accept the distribution, the OHSET's assets shall be distributed to a fund or foundation which is organized and operated exclusively for the purposes specified in section 501c3 of the Internal Revenue Code.

Upon OHSET's dissolution, assets shall be distributed for one or more exempt purposes within the meaning of section 501c3 of the Internal Revenue Code, or corresponding section of any future federal tax code, or shall be distributed to the federal government, or to a state or local government, for public purpose. Any such assets not disposed of shall be disposed of by the Court of Common Pleas of the county in which the principal office of the organization is then located exclusively for such purposes to such organization or organizations, as said court shall determine which are organized and operated exclusively for such purposes.

III - FISCAL POLICY

The fiscal year for the organization will be from July 1st to June 30th. All Districts are required to file a yearly budget and a biannual financial statement with the State Board Treasurer for the periods; (1) January 1st through June 30th; and (2) July 1st through December 31st.

OHSET Bylaws, as Amended: 12.5.2023

WYATT'S TIRE CO.

Eugene, Oregon Since 1925



General Rules

OHSET Rules and Guidelines will take precedent over all other rules. However, USEF, USDF, NRHA, and OWDTA rules will support OHSET if rules are not covered in the OHSET rules and guidelines. Supporting rule books are listed with classes if applicable.

Rule books are listed in governing order. List of events of competition available:

Individual Event Pattern Classes:

Dressage: OHSET, USDF, USEF Chapter DR

United States Dressage Federation

www.usdf.org

United States Equestrian Federation

www.usef.org

Driving: OHSET, ADS

American Driving Society

www.americandrivingsociety.org

Hunt Seat Equitation Over Fences: OHSET, USEF Chapter EQ-2

Hunt Seat Equitation: OHSET, USEF Chapter EQ-2

In Hand Trail: OHSET

Reining: OHSET, USEF, NRHA

National Reining Horse Association

<http://nrha1.com>

Saddle Seat Equitation: OHSET, USEF Chapter EQ-3

Showmanship: OHSET

Timed Events: OHSET

Trail: OHSET (refer to rules of seat style ridden), USEF Chapter WS-3

Western Horsemanship: OHSET, USEF Chapter EQ-4

Working Rancher: OHSET

Team Classes:

Two Man Sorting: OHSET

Team Canadian Flags: OHSET

In Hand Obstacle Relay: OHSET

Two Man Birangle: OHSET

Team Versatility: OHSET

Working Pairs: OHSET

Drill Team - Freestyle Fours: OHSET

Drill Team - Freestyle 5+: OHSET

Refer to **Western States Equestrian Drill Team Association** for list of maneuvers and flag protocol

www.wsedta.com

OHSET Official Contact Information

Oregon High School Equestrian Teams website www.ohset.com

District and School contact information are available on this website.

All communication should be directed through your district chair.

1. Rules

- 1.1. Oregon High School Equestrian Teams (OHSET) Rules and Standard Operating Guidelines (SOG) have been formulated specific to OHSET competition and these rules shall prevail.
- 1.2. The OHSET Rulebook and Standard Operating Guidelines are published by the State Board and are to be followed.
- 1.3. If a conflict occurs in interpretation of a rule or guideline, the OHSET Rulebook will be used first, followed by others as specified in the list of events.
- 1.4. All issues need to be communicated in a timely manner.
- 1.5. If concerning a specific class, communicate prior to completion of the class.
- 1.6. Other issues shall be communicated prior to completion of the meet.
- 1.7. After the new season starts, clarifications will be made public via the OHSET website, www.ohset.com, e-mail, and other appropriate lines of communication including direct communication with the District Chairs and State Board members.
- 1.8. Rule Updates
 - 1.8.1. Will be communicated to districts
 - 1.8.1.1. Districts will communicate to the schools.
- 1.9. New rules that are missed during the printing of the rule book will be communicated via the OHSET website, www.ohset.com, e-mail, and other lines of communication with District Chairs, State Board members, and Judges.
- 1.10. District Stewardship Committee(s)
 - 1.10.1. A Stewardship Committee for District Meets will be formed prior to the start of a competition.
 - 1.10.2. Decisions will be made by the District Stewardship committee.
 - 1.10.2.1. If the conflict cannot be settled through the use of rulebooks and a satisfactory interpretation cannot be arrived at during the District Level Stewardship Committee meeting, the District Chair will attempt to contact the State Rules Chair or the State Chair to solve the issue.
 - 1.10.2.2. If the requester is not satisfied by the District Stewardship Committee decision, the District Chair will send a complete history of the conflict with all sides represented to the State Rules Chair and State Chair. Confidentiality is highly recommended.
 - 1.10.2.3. The State Rules Committee will present recommendations to the State Board for a final decision. An appeal to this decision may be filed with a formal letter and \$50 sent to the State Board. Petitioner may present appeal. The State Board will review and report back prior to the next meet or as soon as possible.
 - 1.10.2.4. The State Board decision is final.

2. Insurance

- 2.1. A general liability policy purchased and maintained through the OHSET organization will cover spectators and bystanders.

2.2. It is recommended that each student/athlete supply their own health accident insurance. Individual schools may require high school athletes to have health insurance.

3. Participation

3.1. General Participation in OHSET

3.1.1. The coaches and advisors forming the equine sport program must follow school, OHSET, and OSAA guidelines.

3.1.1.1. Registered, certified head coaches and advisors must be twenty-one (21) years or older.

3.1.1.2. All registered head coaches and advisors must have taken the OSAA coaches training.

3.1.1.3. All Head Coaches and Advisors must participate in the OHSET coaches training in their first season of coaching/advising effective 2017/2018 season.

3.1.1.4. Assistant coaches and advisors must participate in the OHSET coaches training before they can register for their second season of coaching/advising.

3.1.1.5. Coaches in their first three (3) years must participate in the OHSET coaches training no less than once every two (2) seasons; every season is best.

3.1.1.6. Once any coach or advisor has participated in two (2) OHSET coaches trainings, in two (2) different OHSET seasons, they will only be required to attend every five (5) seasons.

Ex: A head coach starts in the season beginning in 2016, participates in the October 2016 coaches training, then participates again in the November 2017 training; they are not required to participate in the training again until per-registration of the 2022/23 season.

3.1.2. A team must have the approval of the proper authorities of the school as indicated on the team registration form.

3.1.3. Volunteers, coaches, advisors and team support people must understand and sign in agreement, the OHSET Code of Conduct.

3.1.4. Originals of the Code of Conduct and release form must be filed with the District Secretary and be kept available in the office at each meet.

3.1.5. A participation fee, established prior to the competition season, will be charged to each athlete.

3.1.6. Fees must be paid as required by the district prior to participation in any event.

3.1.7. District Rules: All districts will be required to have a copy of the district rules on file with the State. This will be turned in with their registration. Purpose: Immediate resolutions of issues that concern disbursement of money and code of conduct infractions. They can also be used to back up legal inquiries.

3.1.8. New District Chairs will receive the following information and be in agreement to attend District Chair trainings and retreats:

- a) District Chair Handbook
- b) OHSET State Patch
- c) Rulebook

3.1.9. New Advisors/Coaches will receive the following information:

- a) Advisor & Coaches Handbook
- b) OHSET State Patch
- c) Rulebook
- d) Coach certification information as required by the school they represent

3.2. Team Participation in OHSET

3.2.1. Every team advisor and coach will comply with the rules and guidelines as set forth by their high school and OHSET in regard to security and/or criminal history background. Refer to Advisor and Coach expectations

3.2.2. Adult supervision (21 years or older) must be present at all team activities.

3.2.3. The teams that are located in the district will participate and be part of that district

3.2.4. The team can consist of both competing and non-competing athletes (grooms). Only competing athletes will count toward the team's large, medium, small, and mini team designation.

3.2.5. Team Rules: All teams will be required to submit a copy of their team rules to the district. These will be submitted annually with the registration of each school team. A copy of each school's Code of Conduct will be included with this compliance. Purpose: Immediate resolution of issues that concern disbursement of money, Code of Conduct infractions and they can be used to back up legal inquiries.

3.2.5.1. Coaches and advisors may not make any single event mandatory in order to participate on a school team.

3.2.5.2. Coaches and advisors may require participation in a team event for a varsity letter or specific skill levels to ride drill or run timed events, etc.

3.3. Athlete Participation in OHSET

3.3.1. Eligibility: Any high school student, regardless of race, creed, sex, ability, skill level, physical or mental challenge may participate in OHSET.

3.3.2. A student may participate in OHSET for up to four (4) consecutive years, eight (8) semesters, or the equivalent after entering the 9th grade.

3.3.3. All of the athletes representing a school must be enrolled in and attending the school. Exceptions will be addressed by the State Board and will be consistent with the OSAA rules as much as possible.

3.3.4. Students representing a high school shall not compete against unattached individuals.

3.3.5. Each student athlete must supply their own health-accident insurance as required by the high school

3.3.6. Athletes participating in an OHSET associated activity must wear a properly adjusted ASTM/SEI approved helmet while mounted or in a vehicle (cart, wagon, buggy, etc) being pulled by one (1) or more equines.

3.3.7. The student athlete must meet the scholastic requirements and/or the athletic guidelines of OSAA or their school in order to be eligible to participate in OHSET.

3.3.8. Athlete's parents/guardians are responsible for athlete transportation and transportation of their equine.

3.3.9. Code of Conduct Standards and Release: All athletes and their parents or guardian must read, sign, and understand the OHSET Code of Conduct Standards and Release form.

3.3.10. Registration of Athlete: A completed competitor registration form with listed attachments (below) must be signed, filed with team and available at all events and practices.

- Confirmation of Scholastic Eligibility

- Code of Conduct

- Goal and Evaluation sheet

- Health Release Form

Completed registration of each athlete will include:

- Paid participation fees

- Rulebook

- OHSET State Patch

- Athlete number

- Opportunity to be elected as a Youth Rep to the State Board (this is important to college bound Athletes)

3.3.10.1. Registration deadline is January 15. However, an athlete may register until March 1st. Late registrations may incur a late fee at the discretion of the district. Late fees shall not exceed \$25.

3.3.11. Competing Athlete: Student in 9-12 grade interested in competing on an equestrian team who:

- Has a team advisor/coach

- Meet their High School criteria for participation in athletic or club activities

- Meet OHSET registration criteria including, but not limited to:

- a) Register with the district and the state

- b) Total fees paid to state and district

- c) Signed OHSET Code of Conduct and Release form

- d) Copy of medical insurance card required (if applicable)

- e) Scholastic requirements met per school requirements

3.3.11.1. Competing Athletes are entitled to:

- Participate and practice as a rider/handler with team

- Compete as an athlete at District Meets

- Attend and Participate in District and State Board meetings

- Qualify and compete as a rider/handler in the State Meet and Regional competitions

- Receive year end District, State, and Regional Awards

3.3.12. Non Competing Athlete: Student in 9-12 grade interested in participating on a team who:

- Has a team advisor/coach

- Meet their High School criteria for participation in athletic or club activities

- Meet OHSET registration criteria including, but not limited to:

 - Register with District and State

 - Total fees paid to State and District

 - Signed OHSET Code of Conduct and Release Form

 - Scholastic requirements met per school requirements

3.3.12.1. Non-Competing Athletes are entitled to:

- Participate during OHSET practices as the coach permits, functions, and meets as approved by the district

- Non-Competing Athletes may switch to competing athlete at any time as long as approved by the coach and advisor, and all fees are paid equal to competing athletes

- Non-Competing Athletes participation may include, but is not limited to:

 - Groom

 - Team Manager

 - Team Secretary

 - Team Treasurer

 - Stall Cleaner

3.3.13. Non-Competing Athlete: Student in 8th grade interested in being involved with an existing OHSET team, completes OHSET registration criteria including, but not limited to:

- Register with District and State

- Total groom fees paid to District

- Signed OHSET Code of Conduct and Release Form

- Attend the feeder middle school for that OHSET team's high school

3.3.13.1. Non-Competing Athletes in 8th grade are entitled to:

- Attend OHSET team meetings, practices, and events. They may not participate in the team practices or compete at meets. No coaching interactions with the 8th grade members is permitted.

- 8th grade Non-Competing Athletes involvement with the team may include, but is not limited to:

 - Groom

 - Team Manager

 - Team Secretary

 - Team Treasurer

 - Stall Cleaner

3.4. Athlete Participation in District Meet

3.4.1. An athlete may participate in up to five (5) individual events, and all team events. Athletes may only ride in each individual or team event one (1) time per meet.

3.4.1.1. Athletes from a school participating in a Team Event must be of the same discipline including the same color shirt for uniformity. Ex: IHOR class all members of Team A will be all English or all Western style (not 3 English and 1 Western).

3.4.2. Points for events in all three (3) meets will be added together

3.4.3. Athletes will wear assigned number in the arena while participating

3.5. Alternate Participation in OHSET

3.5.1. One (1) alternate will be allowed for all team events.

3.5.2. A new team is formed when anyone other than the original athletes, including their designated alternate, ride in that event.

3.5.3. No alternates will be named prior to the first meet.

3.5.3.1. Exception: Two Man Sorting may list an alternate prior to the first meet.

3.5.3.1.1. An alternate listed in Two Man sorting must compete during at least one (1) round during that meet to remain an alternate for that team.

3.5.3.2. Once an athlete is drawn from the pool of alternates and rides on a team, athlete becomes a permanent member of that team and that team can use no other alternates.

3.5.4. In case of injury or illness, if a team in team events has no alternates, the team may ride short if they have a physician's written statement or a stewardship committee's approval.

3.5.5. Any team event at the State Championship that allows alternates, the alternate pool may include any athletes that are not participating in the state meet in that particular event. Teams may choose up to One (1) new alternate for any team event.

3.5.6. At the State Meet, alternates must be declared before the first athlete enters the gate for a specific event.

3.6. Combination Team Participation (COMBO)

3.6.1. Each application for a Combination Team will be evaluated and voted upon by the district board based on individual merit.

3.6.2. Exceptions to OHSET's combination team process may be made due to specific circumstances. In no case shall an exception granted be deemed a precedent on which to base future combo decisions.

3.6.3. Only schools may apply for a combination team, not families or individuals.

3.6.4. Recruitment of athletes, and any conduct or circumstances toward that end, or to the appearance thereof, is to be strongly discouraged; and any application determined to promote recruitment will be denied.

3.6.5. Definitions:

3.6.5.1. Combination Team Student(s): attending a high school that has four (4) or less competing athletes, applies, as a school (known as the applying school), to participate with another high school for the only purpose of competing in a team event or events.

3.6.5.2. Applying Team: The school that does not have enough athletes to field a team for a specific event and is applying to combine with another school

3.6.5.3. Sponsoring Team: The school that will combine with the applying school's students in team events for OHSET competitions and practice.

3.6.5.4. Recruitment, or 'undue influence' is that attempt by any person (including, but not limited to coaches, advisors, trainers, boosters, teachers, or administrators) to induce a student to attend/participate at a public or private school for the purpose of creating a team of elite competitors.

3.6.6. Team Combo

3.6.6.1. Sponsoring teams have no size limit.

3.6.6.2. Applying teams with more than four (4) competing athletes will not be allowed to combine.

3.6.6.2.1. Applying team cannot combine with two (2) different schools.

3.6.6.3. Both of the combination teams must submit in writing, stating who the applying school is and who the combining school is. This information should be addressed to the District Board, on the proper form, to the District Chair for review and approval by the District Board of Directors.

3.6.6.4. Team Combo Procedure for Approval

3.6.6.4.1. The Head Coach and Advisor of the sponsoring school must sign the application

3.6.6.4.2. The Head Coach and Advisor of the applying school must sign the application

3.6.6.4.3. Each completed application will be reviewed for approval at the next regular District Board meeting, and if approved, notification is to be sent to the State Board. All requests and approvals from application to District Board approval must happen between October 1st and January 31st of the current season.

3.6.6.5. Approved team combinations exist only for the current season

3.6.6.6. There will be no restrictions on State Championship or PNWIC participation

3.6.6.7. Points are awarded equally to both combination teams

3.6.6.8. Combination teams may compete in their respective school's uniforms/ colors with their unique athlete number

3.6.6.9. Alternates - If alternates are used, both combination schools make up the alternate pool

3.7. Equine Participation in OHSET

3.7.1. The team advisor/coach must be informed of any health issues that would affect the participation of the equine athletes.

3.7.1.1. Equine requiring any controlled medication will be identified prior to competing in an OHSET event. Athletes are to inform and communicate the need for such medication to their team coach/advisor including a veterinary prescription, prior to competing at current District or State Meet.

3.7.1.2. Obvious lameness or unsoundness detected in participating horses can/will result in disqualification, the only exception to this statement and rule is:

3.7.1.2.1. Equine must have written veterinary permission to perform and includes the statement 'will not further the injury or cause increased pain'.

3.7.1.3. Drugging horses/lameness: OHSET Organization and its Board Members do not condone the use of drugs, herbal compounds, or surgical procedures which affect an animal's conformation, appearance, or natural performance.

3.7.2. Cruelty

3.7.2.1. If cruelty is reported, it will be investigated and appropriate action taken. If persistent, it will be reason for elimination from the event or disqualification from that meet.

3.7.2.2. Refer to Code of Conduct violation procedure for appropriate action.

3.7.3. Equines cannot be shared in the same event in a single meet.

3.7.3.1. Equine may be used in the same event from district to district. If more than one (1) athlete qualifies for State with that equine, only one (1) athlete will be able to use it (per event) at the State Championship.

3.7.3.2. Under this rule, Freestyle Drill and Freestyle Fours shall be considered as different events as it relates to horse use only. Horses may be shared by two (2) different athletes, but the same athlete cannot ride in both 'events'.

3.7.4. Equine Age:

3.7.4.1. For competition purposes any equine is considered to be one (1) year old the first day of January following the actual date of foaling. January 1st will be considered the birth date for determining age from then on.

3.7.4.2. Equine five (5) and under in any western event may use a regulation snaffle or rawhide bosal.

3.7.4.3. Equine six (6) and over may use any standard bit for that event or breed (except timed events, working pars, and drill.). Refer to specific class rules for further clarification.

3.7.5. Stallions: No stallions of any age will be allowed to participate in OHSET.

3.7.6. *Once any equine arrives on the grounds for the competition, only registered athletes may school/ride/drive an equine.*

3.7.6.1. *Registered athletes may be assisted by a registered adult while lunging if there is a safety concern.*

3.7.7. If anyone other than a registered athlete mounts/drives/schools an athlete's horse, the athlete will be DQ'd from their next individual event. If the athlete has finished competition the points from their last individual event will be pulled.

4. Athlete Uniform

4.1. Helmet: All athletes participating in an OHSET sponsored riding or (equine drawn) driving activity, MUST wear an ASTM/SEI helmet, properly adjusted according to manufacturer's instructions.

4.1.1. The helmet must maintain the proper adjustment throughout the entire event or a disqualification may occur.

4.1.2. No decorated (adornments of any kind) helmets allowed that did not come factory brand.

4.1.2.1. Exception: Helmet covers: Solid or Multicolored helmet covers are allowed in all events.

4.2. Polo Shirt: Upon entering the arena for an event the athlete must wear a solid colored polo shirt with collar, long sleeves rolled down to the wrist, and shirt tucked in as part of the required uniform.

4.2.1. One solid color, long sleeve polo shirt

4.2.1.1. Should be clean and in good repair (no rips, tears, or holes)

4.2.1.2. Buttons of polo shirt should not be left open in a manner that creates an incident or sloppy appearance.

4.2.1.3. See graphic shirt numbering and lettering requirements and options

4.2.1.4. The polo shirt may ONLY contain the items specifically listed as optional or required. No other additional design/lettering/adornments will be allowed. Optional items MUST be in the designated space that is allowed for them. For example: The school logo must only be in 1a or 1b. It may NOT be in the flag area.

4.2.2. Optional Area (Diagram 1a and 1b)

4.2.2.1. No more than four (4) inches by four (4) inches

4.2.2.2. This area may be used for:

One school logo or one team logo

Athlete name or school name (with or without the words "Equestrian Team")

These items may be on one side or the other or split between the two (2) sides, but may not be duplicated on both sides

4.2.3. Flag is optional and can be a maximum of two (2) inches by three (3) inches

4.2.3.1. The flag must face forward and be on the left sleeve only

4.2.4. Sponsor logo is optional

4.2.4.1. The sponsor logo may be a maximum of two (2) square inches, on the right sleeve only. Only one (1) sponsor logo is allowed on a polo shirt, but may be different for each athlete.

4.2.5. High School Name is optional

4.2.5.1. The maximum font size is three (3) inches and should be printed in one (1) or two (2) parallel lines. The name may not interfere with the number in any way.

Example: Smithville High School (all on line)

or

Smithville

High School (two lines)

4.2.6. Number is required

4.2.6.1. The font size must be a minimum of four (4) inches or a maximum of five (5) inches

4.2.6.2. The number may be pinned on the shirt

4.2.6.3. No additional graphics may be used on the number

4.2.6.4. The font style must be clearly readable

4.2.6.5. Athletes must enter the arena wearing the correct number. Failure to do so will result in a disqualification

4.2.7. Any garments may be worn underneath polo shirt

4.2.7.1. The garment may NOT at any time go higher than the chin of the athlete

4.2.7.2. The garment may NOT cover any portion of the uniform, including the collar. For example, a wild rag, scarf, or turtleneck may be worn under the polo and they may come farther up the neck of the athlete than the collar, but they may NOT cover any portion of the collar.

4.3. Safety vest may be worn by any athlete in any event either under or over the polo shirt, but may not cover the athlete's number that is visible.

4.4. Pants must be proper style for class discipline

4.4.1. Western style pants or jeans of solid color

4.4.2. Breeches or jodhpurs of solid color

4.4.2.1. Saddle seat jodhpurs may be pin striped

4.4.3. Pants must be worn on the outside of the boots during performance classes

4.4.4. Pants may be worn inside the boots in Daubing, Breakaway, Two Man Sorting, and timed events

4.4.5. Pants must be neat, clean with no rips, tears or holes

4.5. Boots must be clean (free from mud/excessive dirt) and in good repair

4.6. Miscellaneous

4.6.1. No adornments are allowed on the uniform

4.6.2. This includes anything pinned, sewn, glued or otherwise attached to uniform with the exception of the athlete's number

4.6.3. Athletes with long hair need to wear it neatly away from the face and take care that the complete number is clearly visible and not blocked in any way.

4.7. Team Event Uniformity

4.7.1. Athletes from a school participating in a team event must be in the same discipline, including shirt color, for uniformity.

Ex: If a team has more than one (1) color for their uniforms, the team in the arena must all be in the same color. "Team A - Blue, Team B - White).

4.7.2. Combo Teams may compete in their respective school uniforms/colors with their unique athlete number.

4.7.3. Athletes participating in team versatility may be of different attire in accordance to their discipline

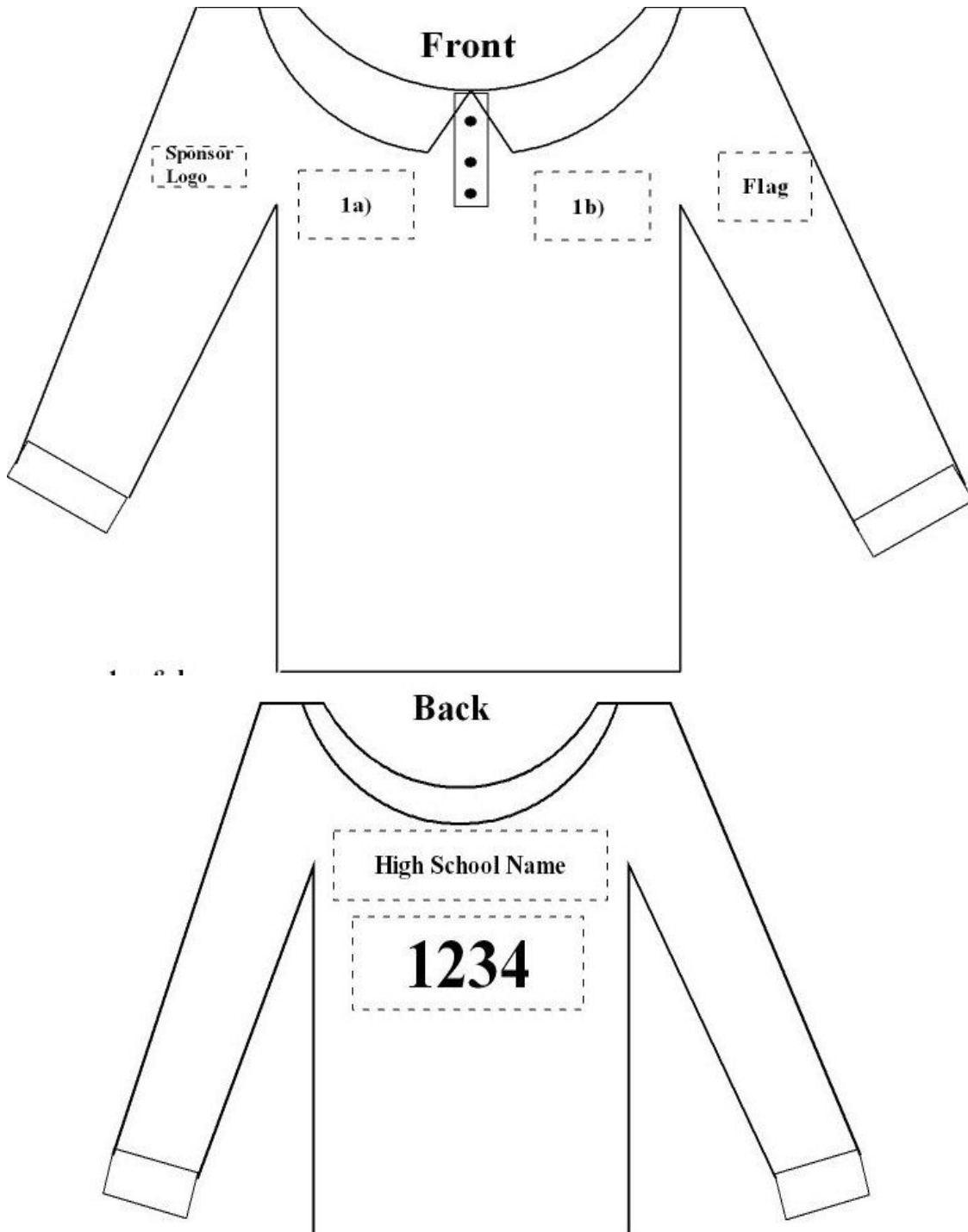

5. Tack & Equipment

5.1. It is the responsibility of the athlete, coaches, and advisors, and not that of the gate crews, to ensure that their competitors are on time, properly uniformed and equipped for each event/class.

5.2. If an athlete enters the arena with equipment that is considered to be unsafe the athlete will not be allowed to continue on the course.

5.3. If an athlete enters the arena with missing required equipment or illegal equipment (including uniform) that is not considered to be unsafe they will be allowed to continue on the course and receive scores and comments but will be disqualified.

5.4. Halters of any style may be used in In-Hand events and will not effect the score or result in a disqualification.

6. The Season & Scheduling

6.1. OHSET season begins November 1st of the current school year and ends after State, Regional, or National competition.

6.2. No equine practices shall occur prior to November 1st of the current school year or after State, Regional, or National competition.

6.2.1. Team practices and coaching must occur ONLY during the scheduled season.

This includes:

6.2.1.1. Selection of events

6.2.1.2. Athletes practicing on foot a specified event. Ex: Drill

6.2.2. OHSET members may gather at any time without equine for a purpose other than practicing, such as fund-raisers and team parties.

6.3. Clinics or other equine related functions may be held outside the scheduled season provided they are open to all schools. Clinic organizers must notify the State Board prior to the clinic to communicate with all districts and obtain appropriate OHSET insurance.

6.4. Each district will hold three (3) weeks prior to the State Championship.

6.4.1. If possible, the competitions should be held at a facility large enough to accommodate all of the events in one (1) weekend.

6.4.2. If it is not possible to hold all the events on the same weekend, events should be scheduled as close as possible.

6.4.2.1. In the event of unfavorable weather, either before or during a meet, the district board holds the right to combine events at future meets, reschedule and entire meet, or cancel events as best suits the districts needs.

6.4.2.2. The District Chair will confer with the state Board

6.4.2.3. There will be a minimum of two (2) competitions available for the athletes.

6.4.3. Districts may combine competition for smaller fielded/larger set up events (Ex: Hunt Seat Equitation Over Fences)

6.5. Schools may field as many event teams as they can

6.5.1. Districts may limit events teams if needed

6.6. District Ride Time Assignment

6.6.1. Meet time slots may be given to schools, not individuals.

6.6.2. If an athlete is not available at the designated team time, that individual's ride may be forfeited.

6.6.3. Drill team order shall be selected by a draw

7. Patterns

7.1. The OHSET State Judges' committee will draw up and submit the patterns for approval by the State Board for each competition year.

7.2. The patterns used at District competitions may be altered for State competitions. However, State Championship patterns shall not use elements not found in the patterns used at District meets during the year.

7.3. Pattern classes will be judged on a 0 to 10 basis for each maneuver, 5 being average. A score sheet will be designed for each pattern.

10 Points	Excellent	Perfect, no improvement possible. Rarely given.
9 Points	Very Good	Hard to fault, but not quite perfect. Rarely given.
8 Points	Good	Outstanding, lovely to watch. Occasionally given.
7 Points	Fairly Good	Nicely performed, above average
6 Points	Satisfactory	Correctly performed with minor mistakes
5 Points	Sufficient	Neither good or bad, noncommittal score
4 Points	Insufficient	Performed, lacking in precision and/or control
3 Points	Fairly Bad	Little response to aids, movement hard to decipher
2 Points	Bad	Attempted, incomplete or difficult to decipher
1 Points	Very Bad	Attempted, incomplete or difficult to decipher
0 Points	Not Performed	No attempt to perform, Rarely given

8. Judging

8.1. Judge selection for district meets will be taken from the current year's OHSET approved judges' list

8.1.1. Apprentice judges requested to officially judge must be approved by the State chair and Judges chair.

8.1.2. If the entire judges' list has been contacted and a judge is still needed for a district meet a judge not OHSET certified may be contacted with approval of both the State Chair and the Judges' Chair.

8.2. Judges' decisions are final in all cases under the scope of their responsibility.

8.3. Judges' evaluation forms should be submitted from each district to the Judge's Committee based on observations and comments on each judge used at OHSET competitions.

These evaluations will serve as a resource for future clinics and constructive improvements for current card holding judges. Judges' evaluation forms are available on the OHSET website.

8.4. Disqualification: "Enters the arena" refers:

- a) Performance Event - Judge's acknowledgment to begin the pattern*
- b) Cattle Event - Athlete nods to release the cow*
- c) Timed Event - Athlete crossing the start/finish line*
- d) Exceptions - Equipment/Safety Inspection Driving/Over Fences*
- e) Team Events - Once the first athlete in a team event performs any of the above in a-c*

8.4.1. If an athlete enters the arena with equipment that is considered to be unsafe the athlete will not be allowed to continue on the course and will be disqualified.

8.4.2. If an athlete enters the arena with missing required equipment, prohibited equipment, or illegal use of permitted equipment, including holding the reins improperly, that is not considered by the judge to be unsafe, the athlete will be allowed to continue on the course of pattern and receive scores and comments, but will be disqualified.

8.4.3. Uniform violations (Reference Section 4)

8.4.4. Obvious lameness or unsoundness detected in participating horses can/will result in disqualification, the only exception to this statement and rule is:

8.4.4.1. Equine must have a written veterinary permission to perform and includes the statement "will not further the injury or cause increased pain".

8.4.5. Violation of any OHSET code of conduct during a district or state competition.

8.5. Elimination

8.5.1. If equipment fails after the athlete enters the arena and is considered to be a safety hazard, the athlete will not be allowed to continue and will be eliminated from the event.

8.5.1.1. Exception: If the equipment fails during drill, time will be called, equipment may be fixed or replaced, and time resumed while the team finishes the drill. There will be a point penalty per occurrence.

8.5.2. Three (3) combined refusals in Hunt Seat Equitation Over Fences

8.5.3. "Off Course" in Hunt Seat Equitation Over Fences

8.5.4. No Time in timed or cattle events

8.5.5. Unintentionally grounded athlete:

8.5.5.1. A mounted athlete who comes off their horse and touches the ground with any part of their body

8.5.5.2. An in-hand athlete touching the ground with any part of their body other than their feet

8.5.5.3. A driving athlete failing to keep at least one (1) hand on the reins

8.5.6. Judges will eliminate any athlete and/or animal they consider to be unsafe.

8.5.7. Cruelty, if persistent, will result in elimination from the event

8.6. Point Deductions (neither elimination nor disqualification)

8.6.1. If equipment fails after the athlete enters the arena and does not present a safety hazard, the athlete can continue and will not be disqualified or eliminated. The equipment failure will be reflected in the horsemanship score.

8.6.2. If an athlete begins the course or pattern with legal equipment, used properly, but then uses the equipment illegally while on course, the athlete will receive a score of zero (0) for each maneuver performed in that manner. All maneuvers performed using equipment legally on the same pattern will be scored normally.

8.6.3. Off Course

8.6.3.1. The “off course” athlete will not be disqualified or eliminated

8.6.3.1.1. Refer to Hunt Seat Equitation Over Fences for an exception

8.6.3.2. Performance athletes will receive zero (0) points for any maneuver of the pattern that is not attempted or skipped.

8.6.3.2.1. Refer to Dressage rules for exceptions

8.6.3.2.2. Refer to Reining rules for exceptions

8.6.3.3. An “element” is all maneuvers in one box for a score

8.6.3.4. A “maneuver” is an individual item of the element

9. Cooperative Sponsorship

9.1. Each application for Cooperative Sponsorship will be evaluated and voted upon based on individual merit.

9.2. Exceptions to OHSET’s cooperative sponsorship process may be made due to specific circumstances. In no case shall an exception granted be deemed a precedent on which to base future decisions regarding cooperative sponsorship.

9.3. Only Schools, Districts, or State organizations may apply for cooperative sponsorship, not families or individuals.

9.4. Recruitment of athletes, and any conduct or circumstances toward that end, or to the appearance thereof, is to be strongly discouraged; and any application presented with that intent will be denied.

9.5. Definitions:

9.5.1. Team Co-op Student(s): attending a high school that does not offer an OHSET program applies, as a school, to compete with a high school that does offer an OHSET program.

9.5.2. District Co-op School(s): apply to compete in a district outside their OHSET district boundaries.

9.5.3. State Co-op State(s) - Other than Oregon apply to compete as an OHSET District(s).

9.5.4. Applying Team: The school that does not offer an OHSET team and is applying to compete with another school.

9.5.5. Sponsoring Team: The school that does not offer an OHSET team and is applying to compete with another school.

9.5.6. Fundamental Rule: It is a fundamental rule of OHSET that a student must attend and represent only the public school located within the public school attendance boundaries of the student's place of residence with parents or guardian.

9.5.7. Home School Students: A student, who meets the home schooled eligibility standards established by Oregon law, may represent the public school or private school where they live. That is the public school within whose attendance boundaries the student and parents of the student reside (curb address). If a private school is located within that public school's attendance boundaries, the home school student may choose to represent that private school. If the public school does not have an OHSET team, then the home school student would ask that public school to form an OHSET team, or follow the OHSET Co-op process for that public school, in order for the home school student to participate.

9.5.8. Private/Charter/Alternative High School Students: Private/Charter/Alternative High Schools may not apply for Cooperative Sponsorship. Their students may form a team at the Private/Charter/Alternative High School where they are enrolled. If their school will not approve a team, they may represent the public school where they live. That is the public school within whose attendance boundaries the student and parents of the student reside (curb address). If that public school does not have an OHSET team, then the Private/Charter/Alternative student would ask that public school to form an OHSET team, or follow the OHSET Co-op process for that public school, in order for the Private/Charter/Alternative student to participate.

9.5.9. GED students (General Education Development): A student, who meets the GED eligibility standards established by Oregon law, may represent a public or private school, located within the public schools attendance boundaries, in which the student and parents of the student reside (curb address). If that school does not have a team, then they would ask that school to follow the co-op process in order for the GED athlete to participate.

9.5.10. Recruitment, or "undue influence" is that attempt by any person (including, but not limited to coaches, advisors, trainers, boosters, teachers, or administrators) to induce a student to attend/participate at a public or private school for the purpose of athletic program participation.

9.6. Team Co-Op

9.6.1. Sponsoring teams having more than nine (9) student athletes will not be allowed to co-op teams.

9.6.2. Applying teams with more than four (4) student athletes will not be allowed to co-op.

9.6.3. Both of the co-op teams must submit in writing, addressed to the State Board, on the proper form to the District Secretary for review and approval by the District Board of Directors, stating who the applying school is and who the cooperative school is.

9.6.4. Each completed application will be reviewed for approval at the next regular meeting, District and then State, following receipt of application.

9.6.5. Team Co-op deadline is the same as the athlete registration deadline during the OHSET season.

9.6.6. Team Co-ops will be approved for one (1) year.

9.7. District Co-Op

9.7.1. Criteria to be considered by applicant:

9.7.1.1. District(s) and State(s), Geographical District boundaries

9.7.1.2. Projected district growth, and/or economical issues

9.7.2. The applying high school(s) must submit in writing to their district on proper OHSET application form. The current district must approve co-op.

9.7.3. The current district sends request to sponsoring district, addressed to the State Board, on the proper OHSET application form to the District Secretary for review by the District Board of Directors, stating who the school is and who the sponsoring district is. The Sponsoring District must approve co-op.

9.7.4. District Co-op deadline is the same as the athlete registration during the OHSET season.

9.7.5. The application is brought to the current district's Board to be approved or disapproved. If approved, the current district signs and forwards the application to the sponsoring district.

9.7.6. The application is brought to the sponsoring district's board to be approved or disapproved. If approved, the sponsoring district signs and forwards the application to the State Board.

9.7.7. The application is brought to the State Board to be approved or disapproved by a majority vote of the State Board of Directors.

9.7.8. Each completed application will be reviewed at the next regular meeting, District or State, following receipt of co-op application form.

9.7.9. District Co-ops will be approved for one (1) year.

9.10. State Co-Op

9.10.1. The Authorized organization official of the applying State must sign the application.

9.10.2. The State approved application is to be sent to the OHSET State Board to be approved or disapproved by a majority vote of the OHSET State Board of Directors.

9.10.3. Each completed application will be reviewed at the next regular State meeting, following receipt of co-op application form.

9.10.4. Criteria to be considered by applicant: OHSET district(s) and states geographical district boundaries, projected district or state(s) growth, and/or economical issues.

9.10.5. State Co-op deadline is the same as the athlete registration deadline during the OHSET season.

9.10.6. State Co-ops will be approved for two (2) years.

10. Scoring/Placing

1st - 20 pts	6th - 11 pts	11th - 6 pts
2nd - 18 pts	7th - 10 pts	12th - 5 pts
3rd - 16 pts	8th - 9 pts	13th - 4 pts
4th - 14 pts	9th - 8 pts	14th - 3 pts
5th - 12 pts	10th - 7 pts	15th - 2 pts
Participation 1 pt		

10.1. Point System

10.1.1. Method of scoring will remain consistent at the State and District level.

10.1.2. State qualifiers at the District level are not official until confirmed by the State.

10.1.3. District results must be submitted to the State Points Chair within one (1) week of each district meet.

10.1.4. Ties are not to be broken at any District Meet or the State Championship in any event, except as noted below for Two-Man Sorting and IHOR.

10.1.4.1. Points are awarded equally to all athlete/teams with scores tied at that placing except IHOR and Two-Man Sorting where time breaks the tie.

10.1.4.2. All athletes/teams with tied scores will receive full points for the position they are tied at.

10.1.4.3. Combo Teams are awarded points equally as if tied.

10.1.4.4. The points for placing below the ties are awarded as usual after the tied position.

Example: Tie for 1st

Score 90 - 1st Place, 20 pts	Qualifies as a 1, 2, 3 finish
Score 90 - 1st Place, 20 pts	Qualifies as a 1, 2, 3 finish
Score 89 - 2nd Place, 18 pts	Qualifies as a 1, 2, 3 finish
Score 88 - 3rd Place, 16 pts	Qualifies as a 1, 2, 3 finish
Score 87 - 4th Place, 14 pts	Does NOT qualify as a 1, 2, 3 finish

Tie for 2nd

Score 90 - 1st place, 20 pts	Qualifies as a 1, 2, 3 finish
Score 89 - 2nd place, 18 pts	Qualifies as a 1, 2, 3 finish
Score 89 - 2nd place, 18 pts	Qualifies as a 1, 2, 3 finish
Score 88 - 3rd place, 16 pts	Qualifies as a 1, 2, 3 finish
Score 87 - 4th place, 14 pts	Does NOT qualify as a 1, 2, 3 finish

Clarification 1: In Hand Obstacle Relay (IHOR) - ties in total score awarded at a meet are broken by lowest time. If still tied, tie is not broken. IHOR ties in year end point totals in a district are NOT broken.

Clarification 2: Two-Man Sorting - OHSET rules used to sort number of successful sorts; number of cattle sorted, and total time. If still tied, tie isn't broken.

10.2. Team Points

10.2.1. Team points, including participation points, are double the individual points.

10.2.1.1. Schools are to be allowed to field as many event teams as they would like.

10.2.1.2. If a school has more than one (1) team in a team event, only the top team's score is counted toward total team points. No participation points are given to remaining teams from the same school.

10.2.1.3. In Drill, at a District meet, a school may earn meet team points from only one (1) drill team - Their highest placing drill team from either Freestyle 5+ or Freestyle 4's but not both.

10.2.2. District may limit event teams if needed

10.2.3. All team points are tracked for State qualification.

10.3. Disqualification (No points awarded)

10.3.1. Points are NOT given for disqualifications listed under 8.3.

10.4. Elimination (Participation point awarded)

10.4.1. Eliminated athletes/teams per section 8.4 will receive participation point(s).

10.5. Off Course - Refer to 8.5.3.

10.6. Re-Rides

10.6.1. Performance re-rides may be awarded or declined at the Judge's discretion

10.6.1.1. Athlete must request a re-ride from the judge at the moment the athlete feels wronged and before leaving the arena.

10.6.1.2. Judge's discretion of what will be permitted for a re-ride, when and where the athlete will begin the pattern.

10.6.2. Cattle Event re-rides refer to section 14.11

10.6.3. Timed Event Re-Rides refer to section 25.8.

11. Year End District Points

11.1. An accurate point count must be kept for every event in the competition and points compiled at the end of the district's competition season.

11.2. Each individual/team's points for all three (3) meets will be added together for ranking.

11.3. Athletes may qualify for a maximum of five (5) individual year-end awards or state qualification.

11.3.1. State Qualifiers at the district level are not official until confirmed by the State.

11.4. Participation points alone cannot qualify an athlete or team for year end awards or the State Championship

11.5. Ties in year end district point totals are not broken.

11.6. Average Event/Class Size

11.6.1. For each district meet, add up the total number of athletes/teams that competed in that event.

11.6.1.1. No-shows and scratches do not count toward event total

11.6.1.2. DNF (did not finish) or DQ's do count toward event total.

11.6.2. Add totals for that event for all three (3) meets. Divide by three (3). All fractions are rounded up.

11.7. A minimum of three (3) and up to a maximum of 10% (rounded up) of the average number of individual/team competitors identified above, of the top year end point earners in each event will qualify for the State Championship.

11.7.1. Top 10% Rule: Multiply .10 times the average event size. If the average event size is 30 (even) or less, that event sends award winners only to State. Note: This may result in more than three (3) award winners going to state if there are ties in the award placing.

11.7.1.1. If average event size is thirty (30) plus a fraction or more, that event sends the top 10% of the average event size.

11.7.1.2. These point result are to be submitted to the State Board of Directors for notification of State competition participants.

Clarification 1: All award winners qualify for State Championship, even if total number of award winners is greater than 10% of event.

Example A: Two (2) athletes tied for first place in district. Average event size is twenty nine (29). Both athletes tied at first place receive gold awards, 3rd highest receives silver, 4th highest receives bronze. All four (4) qualify for State.

Example B: Three (3) Two-Man Sorting teams tied for third place in district. Average event size is 30. Award gold and silver as usual, and three (3) tied teams receive bronze awards. All five (5) teams qualify for State.

Clarification 2: There is a tie at the score for the last qualifying (non-award) spot; all with that score qualify for State.

Example A: No ties in award placing. Average event size is sixty (60). 10% rule would send six (6) to State. There are two (2) athletes/teams tied for sixth place. Both athletes/teams tied for sixth qualify for State.

Clarification 3: 10% rule determines more than award winners will qualify for State, and there is a tie at a position above the last qualifying position. The number of athletes/teams determined with the 10% rule does not increase.

Example A: No ties in award placing. There are two (2) athletes tied for fourth place. Average event size is sixty (60). 10% rule would send six (6) to State. The event sends the top six (6) qualifiers to State.

Clarification 4: If there were originally ties for placings that qualified for State and a qualifier does not attend the State Championship, additional placings/alternates qualify only based on the 10% rule.

Example A: Three Two-Man Sorting teams tied for third in district. Average event size is thirty (30). Award gold, silver, and three (3) bronze awards are given. All five (5) teams qualify. Any of the qualifying teams then declines to attend. No additional (alternate) teams qualify to attend until the number of award winning teams attending the State Championship drops below three (3).

Example B: Three (3) athletes tied for third place in district. Average event size is sixty (60). 10% rule would send six (6) to State. Gold, silver, and bronze awards are given. The top athletes (award winners plus next highest scoring athlete) qualify for State. Any qualifying athlete declines to attend the State Championship, the first alternate is now qualified to attend, keeping the total qualifiers attending the State Championship to six (6).

Example C: No ties in award placing. There are two (2) riders tied for sixth place. Average event size is sixty (60). 10% rule would send six (6) to State. Both athletes tied for sixth place qualified for State. Any qualifier declined to attend the State Championship, no additional athletes qualify to attend until the number of remaining qualifiers attending the State Championship drops below six (6).

Clarification 5: If a qualifier does not attend, and there were only three (3) award winners originally with an event size of thirty (30) or less, and there is a tie for the next alternate position, then all tied at the position are eligible to attend State.

Example A: No ties in award placings. There is a three-way tie for fourth place. Average event size is thirty (30). The three (3) award winners qualify for State. Any award qualifier declined to attend State, all three (3) alternates tied for fourth place now qualify to attend.

12. Awards

12.1. District Awards

12.1.1. The top three (3) individual and team event winners will be awarded gold, silver, and bronze medals respectively.

12.1.1.1. Only individual event points count towards high point calculations.

Exception: Team Contributor

12.1.1.2. An athlete must have an official time in order to medal in roping and daubing.

12.1.2. High Point team of all designations (Large, Medium, Small, and Mini) will be awarded a team trophy.

12.1.3. At a minimum, the following Individual High Points and Reserve High Points will be awarded:

12.1.3.1. Performance

12.1.3.1.1. Highest and 2nd highest point earners when all individual performance event point totals are tallied.

12.1.3.2. Timed Event

12.1.3.2.1. Highest and 2nd highest earner when all individual timed event point totals are tallied.

12.1.3.3. Team Contributor

12.1.3.3.1. Highest and 2nd highest point earner is only team events.

12.1.3.4. Versatility

12.1.3.4.1. Highest and 2nd highest point earner in a combination of timed and performance events

12.1.3.4.1.1. Athlete must ride a 3-2 combination; meaning they must ride either three (3) individual performance events and two (2) individual timed events or three (3) individual timed events and two (2) individual performance events.

12.1.4. Rookie of the year

12.1.4.1. Rookie is defined as a first year OHSET member, any grade

12.1.4.2. Highest individual point earner in their first OHSET year

12.2. Districts may determine other awards as appropriate

12.3. Additional details are available under the Awards Standard Operating Guideline, ~~*found in the appendix of this rule book.*~~

13. State Meet

13.1. State Stewardship Committee

13.1.1. The State Stewardship Committee will consist of the State Chair, State Event Coordinator, State Rules Chairperson, State Judges Chairperson and one (1) adult and (1) youth District representative from each of the respective districts with a minimum of five (5) districts.

13.1.2. While a district may be represented by an adult and a youth, that district will only have one (1) vote.

13.1.3. The State Meet will continue on schedule while stewardship meetings are being held.

13.1.4. Event(s) may be halted at State Chair or Event Manager's discretion.

13.1.5. Decisions made by the State Stewardship committee are final.

13.2. Communications

13.2.1. The basic communication flow within OHSET is outlined in the Communications & Expectations Standard Operating Guidelines (SOG) which may be found on the OHSET website ~~*and in the Appendix of the rule book.*~~ This same communication flow will be in place for the State Championship.

13.2.2. In all events at the State Championship, Gate Stewards will be easily identified by wearing brightly colored vests. These volunteers will be the point of contact to check into the event and determine a competitor's order of go.

13.2.2.1. Any dispute/protest will not be registered with the Gate Steward.

Dispute/protest will be registered with the appropriate District Chair and forwarded through the appropriate channels to the State Championship Stewardship Committee.

13.3. Code of Conduct

13.3.1. All athletes, volunteers (coaches/advisors, parents) and persons contracted with (Judges, Timers, and Stock Contractors) OHSET during and OHSET competition shall comply with the OHSET Code of Conduct.

13.3.2. Any violation of the standards contained therein will lead to a confidential investigation and appropriate disciplinary actions.

13.4. State Awards

13.4.1. Awards are given at the end of the State Championship Meet.

13.4.2. See Standard Operating Guidelines (SOG) for details.

13.5. State Championship Qualifications

13.5.1. State Championship qualifying athletes will be determined by year end point totals at the District level.

13.5.2. All medal winners qualify for State Championship

13.5.2.1. Athlete/Team must compete in an event in two (2) of the three (3) meets to qualify for that event at State Championship.

13.5.3. District and State record breakers

13.5.3.1. District and State record breaking athletes must break a record at an OHSET recognized timed event in the current season.

13.5.3.2. When a new event is added the only automatic qualifier is the athlete holding the current district record.

13.5.3.3. If a record is not broken, previous year(s) record holder does not automatically qualify.

13.5.4. Athletes placing 1st, 2nd, or 3rd in two (2) meets, (DM) in the same event qualify for the State Championship.

13.5.5. 10% of average event size qualifies for State Championship (includes award winners).

13.5.6. Athletes must have earned points other than participation points in that event during the season.

13.5.7. Districts will only name three (3) alternates as state qualifiers in each class.

13.5.7.1. Alternates can be declared at the State Meet up until the first athlete enters the gate for that specific event.

13.6. Clarification, State Qualifiers/Alternates

13.6.1. When an Athlete/Team qualify only as a DM/DR, they are always in addition to the normal allotment for the class - over and above the amount based on medalist and or the 10% rule. Initially, our alternate process works as usual, ignoring the DM/DR qualifier.

13.6.2. However, that DM/DR qualifier also sits at a season point total that would have listed them as some level of alternate (1st, 2nd, tied for 3rd, 4th, etc.) Our alternate pulling-in-process works as usual, ignoring the DM/DR qualifier, until you reach the point total level in that class for the DM/DR qualifier. At that point, the DM/DR qualifier then fills the qualifier spot according to their alternate status, and the class back to sending their normal allotment, based on medalist, and the 10% rule. So, the DM/DR qualifiers are above the normal allotment only until they qualify anyways as an alternate. Then its back to the standard alternate process, with them filling an alternate spot based on their season point total.

13.7. Proof of age of equine, veterinary prescriptions or directions, and other rule exceptions must be provided upon request.

3.8. Judging at State Championships

13.8.1. Performance Classes will be double judged (2 Judges)

13.8.2. Drill Classes will be quad judged (4 Judges)

13.8.3. Timed Events will be judged, timed and electronically recorded.

13.8.3.1. These events will include an official judge, official timer, and official back up timer.

13.8.4. IHOR - At the state meet the use of an electronic timer will be used and time will be displayed for athletes/spectators

13.8.4.1. The line judge will use a hand-held stopwatch and record a backup overall time.

13.8.5. All arenas will be certified by the judge assigned to that event.

13.9. Practice obstacles may be set up in arenas or other safe areas only with permission of State Meet officials

13.9.1. Practice obstacles approved by State Meet officials must be announced and available to all participating athletes for practice.

13.10. Only registered OHSET athletes may ride, *lunge*, or drive in an arena or warm up area at the State Meet.

13.11. State Stalls

13.11.1. Refunds for stalls will be refunded in case-by-case situation

13.11.2. Athlete must request a refund with the following

- a) Letter to State Board with reasoning of why a refund is needed
- b) Letter from doctor and/or veterinarian

13.12. Campsites

13.12.1. Refunds for camping will be refunded on case-by-case situation

13.12.2. Athlete must request a refund with the following:

- a) Letter to State Board with reasoning of why a refund is needed
- b) Letter from doctor and/or veterinarian

OHSET

State Championships

Redmond, Oregon

May 9-12, 2024



PNWIC

June 14-16, 2024 - Washington

14. Cattle Events: ~~Team Penning~~

14.1. Cattle events will be conducted in an arena of adequate size (i.e. 90'x200')

14.2. Arena footing conditions must allow for safe and competitive conditions

14.3. Seating must be adequate to allow spectators to view all events

14.4. The arena will be inspected and approved by the head judge of the event

14.5. Districts shall have the option of using horned cattle. No horns are preferred.

14.5.1. If horned cattle are used, horns are not to exceed two (2) inches.

14.6. Roughing: An athlete may be given a warning or a no time for any action the judge deemed to be unnecessary roughness to the cattle, or the equine, or unsportsmanlike conduct.

14.7. Fall of rider, or rider dismounting, will result in an elimination for that go.

14.8. Equipment:

14.8.1. Two Man Sorting/Breakaway Roping/Steer Daubing Equipment:

14.8.1.1. Required Equipment

14.8.1.1.1. Western bridle or hackamore

14.8.1.1.2. Western type saddle with horn

14.8.1.1.3. Roping, Romal or mecate reins

14.8.1.1.3.1. Split Reins permitted in two-man sorting ONLY

14.8.1.1.4. Rope in Breakaway Roping

14.8.1.2. Prohibited Equipment

14.8.1.2.1. Halters Only

14.8.1.2.2. Chaps & 1/2 Chaps

14.8.1.2.3. Split reins even if tied or joined together in Breakaway Roping/Steer Daubing

14.8.1.3. Optional Equipment: If used must follow requirements

14.8.1.3.1. Martingales, fitted properly as to not pose a danger if horse falls or athlete loses control (to be decided by judge).

14.8.1.3.1.1. Rein stops, rubber or leather stops slipped onto the rein between the bit and the ring of the martingale, are required with the use of a running martingale.

14.8.1.3.2. Rope must be properly secured to the saddle

14.8.1.3.2.1. Rope may not pass through bridle, tie down, neck rope, or any other device.

14.8.1.3.3. Tie downs attached to or under breast collar, fitted properly as to not be a danger if equine falls or athlete loses control (to be decided by judge).

14.8.1.4. Roping string will be provided by the State Board to each district and the state championship and will be a 90lb test strength.

14.9. The cattle holding area will be screened from the competitive area to prevent the active herd from bunching next to the herds waiting rotation.

14.10. Determining order of go:

14.10.1. Two Man Sorting - Order of Go

14.10.1.1. Districts may adopt either the State formula below or their own so long as it adheres to all herd and other rule requirements (i.e. not working on the same herd more than once).

14.10.1.2. At the State Meet the placement of teams for two man sorting in the first go shall be a blind draw. Thereafter, teams shall stay together within the group formed by their “herd change”. For the second go the team order will rotate by half as have each team sort in the first portion and second portion of their “herd change”.

14.10.1.3. Once the events order of go is determined it will not change for any reason. If the team misses their go they receive a forfeit of their go and their cow number will still be drawn and announced as ‘used’.

14.10.2. Breakaway Roping/Steer Daubing - Order of Go

14.10.2.1. Each athlete will receive a chute draw for each round

14.10.2.1.1. Chute draw is defined as the athlete’s cow will be the one that enters the chute in order of the draw.

14.10.2.1.2. If an athlete is disqualified before the release of the cow, that cow must be sent to the catch pen. The next athlete in the order of will “draw” the next cow that enters the chute.

14.11. Re-Rides

14.11.1. If an athlete or team feels they deserve a re-ride, the athlete/team must request one before leaving the competition arena.

14.11.1.1. In breakaway roping the re-ride request must also happen before throwing the first loop.

14.11.1.2. In steer daubing the re-ride request must also happen before attempting to daub.

14.11.2. Once the athlete/team has committed to the cattle, no re-ride will be given, except in unusual circumstances permitted by the judge. Committed to the cattle means that the team has crossed the start/foul line or nodded for the cattle to be released from the chute and pursued, the judges flag has dropped to start time, and the time has begun.

14.11.3. If an athlete/team observes an unfit or injured animal, before committing to the cattle, the athlete/team must notify the judge.

14.11.4. No re-ride will be given due to faulty or broken equipment furnished by the athlete.

14.11.5. In the case of an official or mechanical failure or another condition that an athlete could not have been aware of, the judge has the discretion to issue/offer a re-ride even if the athlete pursued the cattle.

14.11.5.1. If the timers fail and a re-ride is given, penalties incurred in the original go will not carry over to the re-ride.

14.11.6. If an animal leaves the arena, the athlete/team can be given one of the following:

14.11.6.1. If the cow escapes from the arena during the allotted time or re-enters the roping boxes, the flag will be dropped and the athlete/team will receive a re-ride. Time from when the cow left the arena will be added to the re-ride time. If the time was not recorded, the athlete will receive a ten (10) second penalty. No barrier will be used in breakaway roping/steer daubing.

14.11.6.2. A 'no time' for unnecessary roughness

14.11.6.3. A qualifying time on their remaining cattle

14.11.6.4. A re-ride (at the end of the herd that the error occurred, using the same number), depending on the judge's decision.

14.11.7. If more than one re-ride is given in any go-round, re-rides will be given in order of occurrence at the end of the same herd in which the error(s) occurred.

14.11.8. Two Man Sorting Specific Re-Rides

14.11.8.1. If the judge rules that a team is entitled to a re-ride, the team will be allowed to ride at the end of the herd where the error occurred and will work the same cattle number.

14.11.8.1.1. In the event a team is given a number that has already been used on a herd during that go, a re-ride must be given immediately upon discovery, using the correct number within the same herd with a full time allotment.

14.11.8.2. Teams receiving a re-ride will start their time at zero (0).

14.11.8.3. As each new team begins a run, there should be a full herd in the arena. In the event not a full herd is in the arena at the time of their run, that team must have a re-ride at the end of the same herd, on their same numbered cattle.

14.11.8.3.1. Times for all other teams with such a mis-numbered herd will remain the same.

14.11.9. Breakaway Roping/Steer Daubing Specific Re-Rides

14.11.9.1. An athlete feeling they deserve a re-ride may request one from either the line judge or the flagging judge prior to throwing the first loop/prior to attempting to daub and before leaving the arena.

14.11.9.2. In the event the athlete is awarded a re-ride, the re-ride will be done at the end of the go, in order of the original draw, with the next available cow.

14.11.9.3. If the flagging judge flags out an athlete that still legally has one (1) or more loops coming, the judge may call for a re-ride.

14.11.9.3.1. Procedure shall be as described in 14.11.6.1. Elapsed time and any barrier penalties will carry over to the re-ride.

14.11.9.4. Breakaway roping/steer daubing athletes receiving a re-ride will start their time at zero (0).

14.11.9.5. If the timers fail and re-ride is given, penalties incurred in the

original go will not carry over to the re-ride.

14.12. Two Man Sorting Event

14.12.1. A team shall be defined as two (2) or three (3) members.

14.12.1.1. One (1) alternate may be chosen from the alternate pool at any time.

14.12.1.2. Any two (2) of the three (3) members may ride any go, any meet, and points will count for that team.

14.12.1.3. Equine may be shared by a sorting team of three (3) between the two (2) goes.

14.12.2. Timing: Two Man Sorting

14.12.2.1. The timing judge will be responsible for starting the clock and lapping each cow as the head judge calls out. This can be done by manual stop watch or an electronic time with hand-held switch.

14.12.2.2. Two (2) back-up timers with manual stop-watches will be positioned near the official and timing judge with the ability to hear the official judge call each cow.

14.12.2.3. Each back-up timer will record the time on their individual timing device for each team.

14.12.2.4. Back-up timers will be designated "B/U 1" and "B/U 2". In the event the back up time is needed the first time will be "B/U 1". In the event "B/U 2" will be taken.

14.12.2.5. Timing for sorting will begin with the official judge drops their flag and says "Start". As each cow crosses the foul line the official Judge will call "cow" and the lap time will be recorded on the stopwatch for each cow. The last 'lap time' recorded will determine the "split time" for that go.

14.12.3. Judges for Two Man Sorting

14.12.3.1. Two (2) judges shall be used. One (1) is the official head judge. One is the official timing judge. Both judges will be placed next to the sorting arena. The official head judge will sit directly on the line.

14.12.3.1.1. The official head judge will call for the cattle ready, state when time should start, when time should lap for each cow that crosses the time, if there is a dirty cow, and when the final time ends.

14.12.3.1.2. The official timing judge will keep a record of when the official head judge calls for time to start, each lap time for a cow crossing, and the final time on the run. This judge will not watch the go but rather listen for the official judge's call for times.

14.12.4. Two Man Sorting Event

14.12.4.1. This is a timed event with a sixty (60) second limit and two (2) goes per team.

14.12.4.2. The herd will be positioned in a group in the back center of the pen, opposite the "in gate" for the athletes, by the team that has just competed. Once grouped and confirmed by the judge the team will exit the pen.

14.12.4.2.1. Ten (10) numbered cattle and one (1) unnumbered cattle, for a total of eleven (11) head per herd.

14.12.4.2.1.1. At the State Championship meet the number of cattle in each herd will increase by one (1) bringing the unnumbered cattle total up to two (2).

14.12.4.2.2. Districts may choose how many herds to use as long as there are a minimum of two (2) and each herd is used evenly.

14.12.4.2.2.1. At the State Championship at least three (3) herds will be used.

14.12.4.2.3. At least one (1) number in each herd will go unused.

14.12.4.2.4. Teams will not be asked to sort on the same herd twice during a meet.

14.12.4.2.5. Not all teams will compete on all herds if more than two (2) hers are used.

14.12.4.2.6. The judge holds the right to pull any cow they deem unruly or intentionally sabotaging the team.

14.12.4.3. As the competing team has completed their run and the cattle are securely in the back pen and the complete team has exited the pen, the next team will immediately enter the pen.

14.12.4.4. When the judge signals by the raising of their flag and the announcer stating “cattle are ready”, the competing team will cross the start/foul line.

14.12.4.4.1. If the herd spreads before the judge calls for “cattle are ready”, the judge will ask an athlete about to compete to bunch the cattle again and get back across the line to begin the run.

14.12.4.4.2. If athletes cross the start/foul line before the judge signals and without permission from the official judge, the team will be eliminated for that run.

14.12.4.5. As the first horses nose crosses the foul line the official judge will say “start” and begin their watch while dropping their flag beginning the time for that run.

14.12.4.5.1. As the official judge says ‘start’ the timing judge and back up timers will begin their stop watches.

14.12.4.5.2. As the official judge says start and drops their flag the announcer will call out the number the team will begin sorting from.

14.12.4.6. The team sorting will begin with the number called out by the announcer and move each cow sequentially to the opposite pen. As each cow’s nose breaks the start/foul line, the official judge will call out “cow” while hitting the “lap” feature on their watch.

14.12.4.6.1. As the official judge calls out “cow” the timing judge and back-up timers will hit the “lap” feature on their watch.

14.12.4.7. Each cow must pass through the foul line in sequential order.

14.12.4.7.1. If the nose of a cow not in sequential order breaks the plain time will stop and the team will receive a no time for the go.

14.12.4.8. Teams may opt to sort up to any number of cattle and then hold the cattle in place for the remainder of the sixty (60) seconds.

14.13. Placing

14.13.1. Two Man Sorting placing will be determined by the number of successful sorts, followed by the most cattle sorted, and finally the least amount of time.

14.13.1.1. A successful sort is considered at least one (1) cow across the line in the correct order.

14.14. Breakaway Roping/Steer Daubing: Timing

14.14.1. The cattle handers shall be consistent throughout the event

14.14.2. Athletes may come out of either side of the box.

14.14.2.1. Athletes MUST have their equine facing out of the box before they ask for the steer to be released.

14.14.2.2. A coach, advisor, or registered adult volunteer may bring the equine in the arena and/or into the box.

14.14.2.3. Any physical encouragement of forward motion or holding back by anyone other than the rider will be an elimination for that go.

14.14.3. Timing for Breakaway Roping/Steer Daubing

14.14.3.1. Electronic eyes will be used for all barriers

14.14.3.1.1. If an electronic eye is unavailable or broken during the event, the event will be postponed until an electronic eye is available.

14.14.3.1.2. All events will be measured and recorded to the thousandths place (16.001). Additional numbers beyond the thousandths place will be dropped, no rounding.

14.14.3.2. The height of the barrier will be set at 32"-36" measure from the center of the box.

14.14.3.3. The cow's nose must break the six (6) foot barrier from the equine to leave the box.

14.14.3.3.1. A ten (10) second penalty for breaking the barrier will be added.

14.14.3.3.2. In the event of a barrier malfunction, and the judge confirms, the athlete will receive an automatic re-ride.

14.14.4. Two (2) judges will be utilized for these events.

14.14.4.1. The flagging judge will be horseback whenever possible, be considered the head judge for the event, and will raise their flag signaling the arena is ready for the next athlete.

14.14.4.1.1. Prior to the events, the flagging judge will inspect the cattle and eliminate any that they find objectionable.

14.14.4.1.2. During the events, the flagging judge will determine legal catches/daubs and/or any rule infractions.

14.14.4.1.3. The flagging judge will position themselves in the following positions and remain in the same position throughout the “go”:

a) Breakaway Roping: Against the right side (heel box side) of the arena, approximately 2/3rd of the way down.

b) Steer Daubing: On the left side (head box side) of the arena, approximately 1/2 of the way down. Does not need to be against the wall.

14.14.4.1.4. Occasionally because of arena size or orientation, a judge may choose a different location.

14.14.4.2. The line judge will position themselves at the cattle barrier line and will signal the announcer to call for the next competitor.

14.14.4.2.1. The line judge will keep the time for the athlete entering the box.

14.14.4.2.2. The line judge will call out at forty-five (45) seconds to warn the athlete they have fifteen (15) seconds remaining.

14.14.4.2.3. If the athlete is not in the box and ready (shall be defined as facing the front of the “box” and asking for the calf to be released) when sixty (60) seconds are up, the line judge will signal the announcer and the athlete shall be awarded a “no time”.

14.14.4.2.4. The line judge will check the string before entering the box to ensure it is secure to the horn.

14.14.4.2.5. The line judge will determine if the athlete broke the barrier

14.14.4.3. Both the line judge and the flagging judge will monitor the athlete to ensure no rule violations while in the “box”.

14.14.4.3.1. In the event of a protest, the flagging judge will coordinate with the line judge and then, if requested, will confer with the stewardship committee.

14.14.4.4. If a judge sees an error in flagging/*timing* the judge *has the option* to offer a re-run before the athlete leaves the arena.

14.14.5. Order of Operations:

14.14.5.1. When the flagging judge is in position and determines the arena is clear they will raise their flag.

14.14.5.2. When the line judge sees the flagging judge raise their flag, the line judge will ensure the cow is in the chute and there is a clear entrance into the chute for the athlete and raise their flag.

14.14.5.3. When the line judge raises their flag and the announcer calls the athletes number and name, the athlete has sixty (60) seconds to enter the box and signal for their cow to be released.

14.14.5.3.1. In Breakaway roping this is when the judge will check each rope to confirm it is secure, by a strong tug of the rope.

14.14.5.3.2. If the string should break, or the rope come loose, the athlete has the remainder of the sixty (60) seconds to re-tie, be re-checked by the

line judge and ask for their calf.

14.14.6. Breakaway Roping

14.14.6.1. This is a timed event with thirty (30) second limit with two (2) goes per athlete.

14.14.6.2. One (1) or two (2) ropes are to be tied to the saddle horn by a heavy string provided by the State Board, in such a manner as to allow the rope to be released from the horn when the calf reaches the end of the rope.

14.14.6.3. Two (2) loops will be permitted. ~~**Two (2) loops are allowed only if the athlete is carrying a second loop. Rebuilding the loops is not allowed. Athletes may rebuild or throw a 2nd loop.**~~

14.14.6.4. A visible cloth or flag must be attached to the end of the rope which is tied to the horn to make it easier for the flagging judge to see the rope break free.

14.14.6.5. A legal catch is to be any loop that goes completely over the calf's head and draws up on any part of the calf's body (except the tail) causing the rope to break away from the saddle horn.

14.14.6.6. Time will be started from the drop of the line judge's flag at the barrier and/or by electronic timer as the cow's nose crosses the cow barrier line.

14.14.6.7. Time will be stopped when indicated by the flagging judge dropping the flag after the rope string breaks from the saddle horn.

14.14.6.8. No time will be awarded:

14.14.6.8.1. The athlete breaks the rope from the horn by hand, touches the rope or string after the catch is made, or if the rope dallies around the horse and/or does not break free when the calf reaches the end.

14.14.6.8.2. Roping the calf without releasing the loop from the hand.

14.14.6.8.3. Any attempt by an athlete to position their equine in the box enabling them-self to rope the calf without leaving the box.

14.14.6.8.4. If the athlete has not entered the box and called for their calf within sixty (60) seconds from the time their name is called.

14.14.6.8.5. Fall of rider, or dismounting, will result in an elimination for that go.

14.14.6.8.6. Roughing cattle, as determined by the judge, will result in an elimination for that go.

14.14.6.8.7. Judges will eliminate any athlete and/or animal they consider to be unsafe.

14.14.6.9. Placing will be determined first by the number of successful catches, then lowest total time.

14.14.7. Steer Daubing

14.14.7.1. This is a timed event with fifteen (15) second limit, two (2) goes per athlete.

14.14.7.2. Equipment provided by the district:

14.14.7.2.1. A four foot (4ft) dauber with a tennis ball

14.14.7.2.2. A “bright contrasting color paste” to coat the tennis ball end of the dauber.

14.14.7.2.2.1. The use of mustard is prohibited

14.14.7.3. A successful daub is placed inside of an imaginary box formed between the “wither like” area and the tail head of the top of the back and a line between the knee and the hock, exclusive of the tail.

14.14.7.4. Athlete must raise the four (4) foot dauber in the air. As the athletes hand raises over the shoulder to signify successful daub.

14.14.7.5. Time will stop when the flagging judge drops their flag as the athlete raises the dauber over their head with their hand above the shoulder, stopping the time.

14.14.8. A no time will be awarded:

14.14.8.1. If time is called by the athlete and a mark is not visible on the steer.

14.14.8.2. If the dauber is thrown at the steer or dropped by the athlete *after the athlete has nodded for the cow*.

14.14.8.3. Any attempt by an athlete to position their equine in the box enabling them to daub the steer without leaving the box.

14.14.8.4. If the athlete has not entered the box and called for their calf within sixty (60) seconds from the time their name is called.

14.14.8.5. Roughing cattle, as determined by the judge, will result in an elimination for that go.

14.14.8.6. Judges will eliminate any athlete and/or animal they consider to be unsafe.

14.14.9. Placing will be determined first by the number of goes with successful daubs, then lowest total time.

14.14.10. Records

14.14.10.1. Records will be tracked for all events in each district and State Championship.

14.14.10.1.1. Each district will have a district record in all timed events. The district record shall be earned at a district meet.

14.14.10.1.2. The State Championship will have a State Championship record in all timed events. The State Championship record shall be earned at a State Championship meet.

14.14.10.2. State records will be tracked by single fastest time.

14.14.10.3. The athlete holding the best time in the state is deemed the state record holder, whether the course is run at a District or State meet.

14.14.11. Hazing: Contact with cattle by hands, ropes, reins, or any other equipment as a means to move the cattle, may result in a warning, no time, or disqualification at the judge’s discretion.

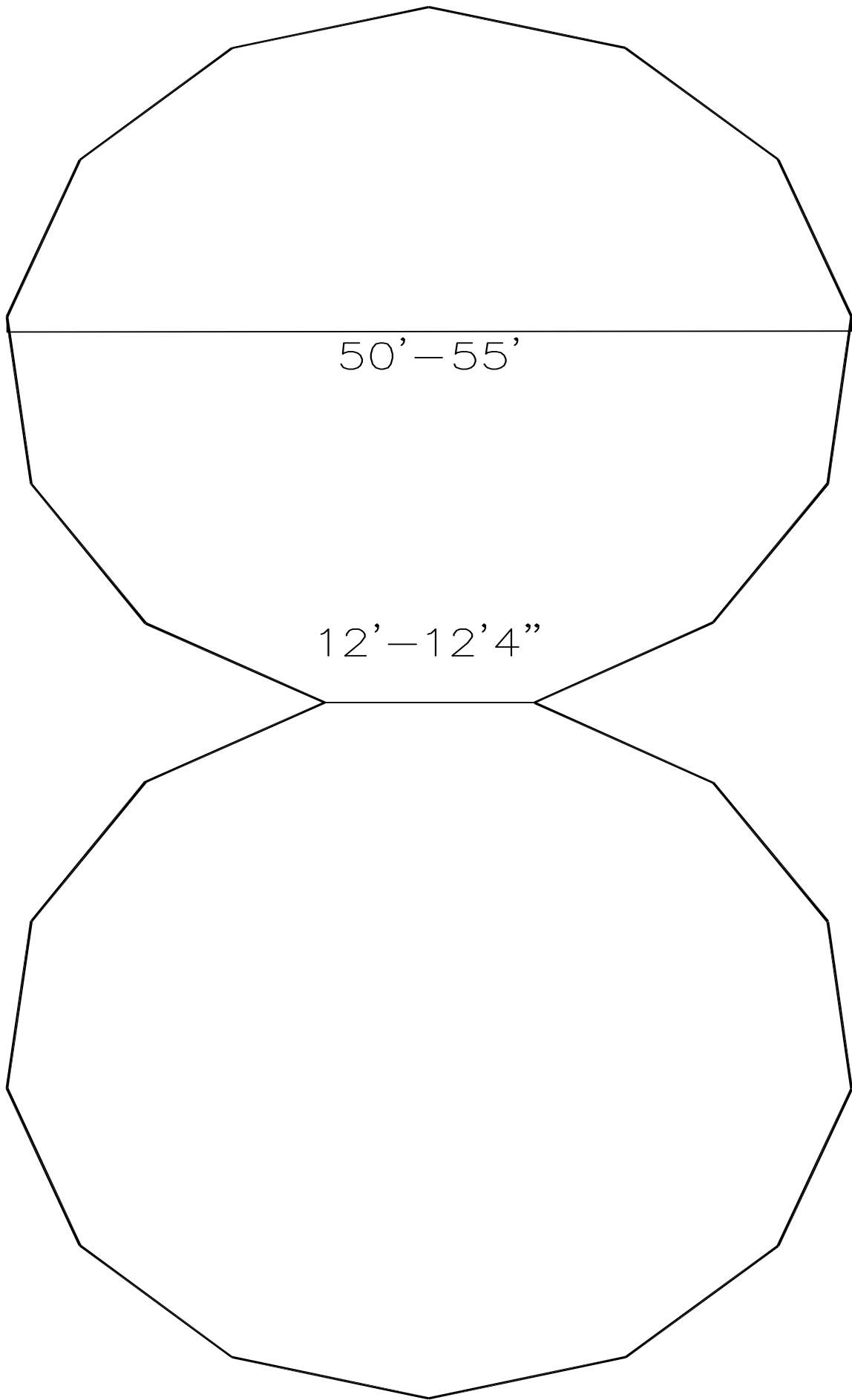

15. Dressage, Dressage Trail

Dressage Rule Reference USEF DR121-2, USDF

15.1. Required Equipment

15.1.1. Bit

15.1.1.1. The only bit permitted is the snaffle bit. All snaffle bits must be smooth with a solid surface.

15.1.1.2. Bit checks may be done, at the discretion of the judge, after the completion of the test. These may be done by a qualified volunteer or a judge.

15.1.1.3. See USDF for more information on acceptable bits

15.1.2. Cavesson

15.1.2.1. Dropped, Flash, Crescent, Crossed and regular nose-bands are the usable options. Padded nose-bands are permitted.

15.1.3. Saddles

15.1.3.1. Dressage, forward, or all purpose saddle

15.2. Prohibited Equipment

15.2.1. Draw Reins

15.2.2. Non-English type spurs

15.2.3. Western, Sidesaddles, or cutback (saddle seat type) saddles

15.2.3.1. Including Baroque saddles

15.2.4. Ribbon, Glitter, & Sparkle

15.2.4.1. Exception: Residual from Working Pairs or IHOR when schedule does not allow its removal

15.2.5. Any bit with a twist in the metal

15.2.6. Martingales

15.2.7. Bit guards

15.2.8. Protective boots

15.2.9. Leg wraps

15.2.10. Bandages

15.3. Optional Equipment: If used must follow required guidelines

15.3.1. Spurs of an English type

15.3.1.1. Spurs-made of metal, shank must be curved (pointing down) or straight pointing directly back from the center of spur. If rowels are used, they must be free to rotate.

15.3.2. Crops, bats, or whips may be no longer than 47.2” for dressage including lash
~~Removed: Whips of any kind will not be allowed at the State Championships, but will remain an option at District meets~~

15.3.3. Brow-bands may be multicolored and may be decorated with metal, beads, gemstones, and crystals. Non-metal decoration on the surface of the nose-band is permitted.

15.4. Judging shall be consistent with USDF rules

15.5. Use of a reader is allowed at district meets, but is prohibited at State Championships.

15.6. Use of a raised Dressage court is required at the State Championships.

15.7. Fall of a horse or rider shall be elimination

15.8. Errors

15.8.1. Wrong turns

15.8.2. Omitting a movement

15.8.3. Movement incorrectly ridden

15.8.3.1. Posting instead of sitting or vice versa 15.8.3.2. Twenty (20) seconds of no forward movement

15.8.4. Wrong gait 15.9. Judging Errors

15.9. Judging Errors

15.9.1. Shall deduct two (2) points for the first occurrence, four (4) points for the 2nd occurrence

15.9.1.1. After the third (3) error, the athlete will be eliminated

15.9.2. The Judge may choose to ring the bell for an error on the test. For example, the rider turns the wrong way or omits a movement. The Judge will instruct athlete as to the nature of the error. Athlete re-rides the test from the point directed by the judge.

15.9.3. The Judge may choose not to ring the bell for an error of the test. Rider incorrectly rides a movement such as posting instead of sitting, incorrect salute, use of voice, etc. Rider does not re-ride the movement. The Error is scored as above.

15.9.4. Use of voice or other intentional audio aid is considered a serious fault

15.9.4.1. Deduction of at least two (2) marks from what otherwise would have been awarded for the movement where the fault occurred.

15.9.4.1.1. In movements with a coefficient the judge may choose to deduct only one mark so after the coefficient is applied the total deducted is two (2) vs four (4) points.

15.10. Eliminations

15.10.1. Three (3) errors of/on the test

15.10.2. Failure to enter the court within forty-five (45) seconds of the Judge ringing the bell

15.10.3. Equine stepping all four (4) feet outside of the court during the test.

15.11. Dressage Trail

15.11.1. Athlete is permitted to use one (1) hand on the reins while working the gate or carrying a required object without it being considered “illegal use of permitted equipment”.

16. Drill Team

16.1. Freestyle Fours - Teams with four (4) riders

16.2. Freestyle 5+ - Teams with five (5) or more riders

16.3. Required Equipment:

16.3.1. Drill team may be ridden with all English or all Western equipment

16.3.1.1. Attire must conform to the discipline of equipment used

16.3.1.2. Athletes from a school participating in a team event must be of the same discipline including the same color shirt for uniformity.

16.3.1.2.1. Exception: Combo teams may ride in their respective school colors

16.3.1.3. Bridles must be worn

16.4. Prohibited Equipment:

16.4.1. Wire chin straps, regardless of how padded or covered

16.4.2. Decoration/costuming of athlete uniform

16.4.3. Any chin strap narrower than 1/2 inch

16.4.4. Draw reins

16.4.5. Jerk lines

16.4.6. Tack collars

16.4.7. Chaps & chinks

16.4.8. Sunglasses

16.4.9. Skirts (sidesaddle)

16.4.10. Bit Converters, A device used on Pelham bits to change them from two-rein bits to one-rein bits. It is a leather strap that attaches from the snaffle ring to the curb ring, onto which the rein is then attached to the loop made between the two rings.

16.5. Optional Equipment: If used must follow requirements

16.5.1. Standing martingales and tie downs must be attached to/or under a breast collar

16.5.2. Running martingales with rubber or leather rein stops slipped onto the rein between the bit and the ring of the martingale are required.

16.6. Judges

16.6.1. Three (3) judges are recommended, but not required at District level.

16.6.2. Four (4) judges will be used at State

16.6.3. If there is equipment failure that is considered to be a safety hazard, the judge may call a time out

16.6.3.1. Official time will be stopped at the judge's signal

16.6.3.2. Time will resume at the signal of the team captain, time will continue from the point it was stopped.

16.7. General Drill Rules

16.7.1. Position in the event schedule will be determined by the event chairman or committee.

16.7.2. All equines will be serviceably sound and in good condition. Any equines showing signs of lameness or unsoundness will not be allowed to compete

16.7.3. Drill team coaches or other athletes will not be allowed in the arena while their team is competing. Coaching or encouraging from outside the arena is permissible.

16.7.4. During drill competition only equines involved in the performance will be allowed in the arena.

16.7.5. During assigned practice periods only the equine in the drill activity will be allowed in the arena.

16.7.6. During practice only coaching staff will be allowed in the arena on foot. All athletes must be mounted.

16.7.7. There is a time limit of four (4) to six (6) minutes per team to perform a drill.

16.7.7.1. Times for length of each drill performance will be recorded on the official scorecard.

16.7.7.2. Time scores are to be taken by official timers and reported to the judges.

16.7.7.3. Time starts when the first rider enters the arena and stops when the last rider leaves the arena

16.7.8. At the State Meet, when a team fails to exit the arena before their two (2) minute warm up time has ended, a penalty deduction of then (1) points will be made for each full or partial portion of thirty (3) seconds they are in overtime.

16.8. American Flag Protocol

16.8.1. Standard per Public Law 94.344 use of the United States Flag;

16.8.1.1. The Flag should never be carried flat or horizontal, but always aloft and free

16.8.1.2. The U.S. Flag should not be dipped to any person or thing.

16.8.1.3. Regimental colors, state, city, organizational or other flags are dipped as a mark of honor

16.8.1.4. Do not let the Flag of the United States touch anything beneath it, such as the ground, floor, water, or merchandise.

16.8.1.5. The United States flag should always be the first in, and the first out, of the arena.

16.8.1.6. The United States flag should always be carried in the front of all other flags.

16.8.1.7. The United States flag should always be carried on the right side of a company front.

16.9. Musical Accompaniment

16.9.1. Teams may ride to music for the purpose of crowd appeal

16.9.2. Should the music stop or there be interruption of malfunctions, the drill shall continue without music.

16.10. Teams

16.10.1. Schools are allowed to field as many drill teams as they would like.

16.10.1.1. Only the highest place team for each high school in a team event will count toward meet team points from either 5+ or 4's, but not both.

16.10.1.2. Before a large team can field a second Freestyle Fours team, they must field a Freestyle 5+ drill.

16.10.2. Athletes can only compete in one (1) drill for any team at each competition.

16.10.3. Horses may be used one (1) 4's performance and one (1) 5+ performance at the state meet.

16.10.4. Rules for listing team members and alternates will follow guidelines as in all other team events.

16.10.5. Teams cannot switch from one drill event to the other after they have made a commitment or they shall forfeit all accumulated points.

16.11. Freestyle 5+

16.11.1. Extenuating circumstances may allow teams competing in the Freestyle 5+ division to ride with less than five (5) athletes in District/State Competitions.

16.11.1.1. It may be considered an extenuating circumstance if an equine or athlete is injured or ill and there is no replacement.

16.11.1.2. The Stewardship Committee shall determine if a situation falls under this rule, and must grant permission before the team rides.

16.12. Freestyle Fours

16.12.1. Shall consist of no less than four (4) athletes

16.12.2. Extenuating circumstances may allow teams competing in the Working Fours to ride with less than four (4) athletes in District/State Competitions.

16.12.2.1. It may be consider an extenuating circumstance if an equine or athlete is injured or ill and there is no replacement.

16.12.2.2. The Stewardship Committee shall determine if a situation falls under this rule, and must grant permission before the team rides.

16.13. Maneuvers.

16.13.1. A list of drill maneuvers and drill design sheets are available on the OHSET web site. www.ohset.com

16.13.1.1. Design sheets are optional for team use only and do not have to be submitted to the judges.

16.13.2. Drills are to be "Freestyle"

16.13.2.1. Teams may choose maneuvers from any source and/or make up their own.

16.13.2.2. There are no required maneuvers or any required number of maneuvers which must be included in drills.

16.13.3. Teams may begin to design their drills after October 1st.

16.13.3.1. Teams may not practice drill with or without an equine until November 1st.

16.14. Explanation of Point Value Deductions. Only the captain/co-captain can call time. Time will stop and re-start on captain/co-captain signal.

16.14.1. Broken or dropped equipment, tack or uniforms twenty points (-20) for each occurrence. Shall include helmets, leg bands, pennants, flags, tail bows or anything that has fallen to the ground or broken in such a manner to necessitate stopping to repair it. The Captain/Co-Captain can call time. Time will stop and start on Captain/Co-Captain's signal.

16.14.2. Collision, no fall of equine or rider twenty-five points (-25) for each occurrence. Shall be deemed to be any physical contact between two (2) or more equine, two (2) or more athletes, or equine and athlete with a wall or gate which does not result in a fall.

16.14.3. Excessive/uncontrolled speed. Twenty-five points (-25) for each occurrence. Riders will be considered to have excessive/uncontrolled speed if athlete loses control or a severe loss of precision due to speed.

16.14.4. Fall of equine and/or athlete, no collision. Thirty points (-30) for each occurrence. A team will be able to halt, regroup and restart as soon as equine and athlete are in position. Same rules for restart as fall due to collision. If a flag athlete falls only the fall of equine and/or athlete will be deducted, not the dropped flag.

16.14.5. Fall due to collision, ~~Fifty points (-50)~~, **Seventy-Five (-75) points** for each occurrence. Shall be deemed to be any physical contact between two (2) or more equine, two (2) or more athletes, or equine and athlete with a wall or gate, which results in a fall. If equine or athlete is unable to continue, a substitute equine and/or athlete will be allowed to fill the position. The position may remain empty.

16.14.6. Regroup. Twenty five points (-25) for each occurrence. May be done when a team has lost its organization and/or athletes must change position to be able to continue. Extenuating circumstances such as severe tack breakage, fall of equines and/or athlete, or medical emergency which results in the team being unable to continue, they may ask the Senior Judge for permission to leave the arena and return at the end of the draw. Time and deductions will remain official; time keeper will record time when performance is stopped by Captain/Co-captain and start time when Captain/Co-captain signals to commence the performance.

16.14.7. Time - Four to Six (4-6) minutes: Twenty-five point deduction (-25) for each occurrence under or over the allotted time.

16.14.7.1. Timing starts when the first athlete passes through the entry gate and/or cones marking entrance and stops when the last athlete crosses the exit gate and/or cones.

16.14.7.2. An official timekeeper will enforce this rule.

16.15. Alternate Guidelines

16.15.1. If a school intends to field only one (1) drill team, they still must name the alternates that may possibly compete this season, "drill alternate pool" (Listing all other competing athletes for the school as alternates is okay).

16.15.1.1. The alternate pool must be named before the first meet.
16.15.1.2. In Drill Teams (Freestyle 4's & Freestyle 5+) there will be unlimited potential use of alternate pool.

16.15.1.2.1. A school may pull 1, 2, 3, 4 or more riders out of the "drill alternate pool" during the season as needed.

16.15.1.2.2. In Drill, once an alternate is pulled from the "drill alternate pool" (i.e. used in a competition), that alternate may ride only on that specific drill team, and no other drill team (in competition) for the season.

16.15.3. EXAMPLE #1: Twelve (12) competing athletes in a school, and the school only fields one (1) drill team - a Freestyle 5+, names five (5) primary riders to the drill team, and can name the remainder of the school's competing athletes, seven (7) to their Drill alternate pool. Any combination of riders from the original named five (5) or from the original named Drill alternate pool may ride in competition at any of this season's meets. Again, when a rider is pulled from their Drill alternate pool, the school's advisor/coach MUST notify the meet office, in writing, BEFORE that Drill team competes at that meet.

16.15.14. EXAMPLE #2: Twenty (20) competing athletes in a school, and the school fields two (2) Drill teams, one 5+ and one Freestyle 4's. The school names four (4) primary riders to the Freestyle 4's team and six (6) primary riders to the Freestyle 5+ team. That leaves the remaining riders that can be named to the Drill alternate pool. When a member of the alternate pool is pulled and competes for one (1) of the drill teams, they are then a part of that team, for the remainder of the season, are no longer in the alternate pool, and may not compete with the other Drill team. Their Drill alternate pool has now dropped by one rider. Those remaining members in the Drill alternate pool are eligible to compete for either Drill team at any competition.

North Hills

Construction Co.

GeneralContractors

Commercial/Industrial
Custom Residential
Tenant Improvements
Reconstruction
24hr. Emergency Service

9825 NW Kaiser Road
Portland, OR 97231
Business (503) 292-4556
Cell (503) 312-1067
northhillsconst@aol.com

CCB# 115445
Licensed, Bonded, Insured

Scott B. Chauncey

17. Driving

Reference American Driving Society

17.1. Required Equipment:

17.1.1. Blinders

17.1.2. On heavier vehicle, Thimbles or Breeching is required

17.1.3. Over Checks or Side Checks

17.1.4. Whip - (tip of the whip or lash must be long enough to reach the should of the equine) must be held and used correctly

17.2. Prohibited Equipment:

17.2.1. Twisted or wire bits of any type

17.2.2. Boots or wraps of any type

17.2.3. Spurs

17.2.4. Gag bits

17.3. Optional Equipment: If used follow requirements

17.3.1. Running martingales with rein stops, rubber or leather stops, slipped onto the rein between the bit and the ring of the martingale.

17.4. Headers

17.4.1. Headers are required any time the equine is hitched to the driving vehicle except while the competitor is working their pattern.

17.4.2. Must be a registered volunteer or athlete

17.4.3. Athletes participating as headers must be in a team uniform

17.4.4. Boots are required for all headers

17.4.5. Spurs are prohibited

17.5. A safety inspection of equipment, by the Judge, will be performed prior to event

17.5.1. Equipment checks are part of the score. Grooming and clean gear will be noted and will be considered in the overall reinsmanship scoring.



18. Hunt Seat Equitation, Hunt Seat Trail

Reference Rules USEF Chapter "EQ"

18.1. Required Equipment

18.1.1. Saddle

18.1.1.1. Forward Seat Saddle, Multipurpose, English type saddle

18.1.2. Bits

18.1.2.1. Regulation snaffle, Pelhams, full bridles, kimberwicks, all with cavesson nose-bands

18.2. Prohibited Equipment:

18.2.1. Draw reins

18.2.2. Non-English type spurs

18.2.3. Western, Sidesaddles, Saddle Seat style cutback saddle, Dressage saddle

18.2.4. Bit converters

18.2.5. Gag bits

18.2.6. Ribbon, glitter, & sparkle (Exception: residual from working pairs when scheduling does not allow its removal.)

18.2.7. Figure 8, Flash, or Dropped nose-band

18.2.8. Martingales

18.2.9. Protective boots, leg wraps and bandages

18.2.10. Side Pulls

18.3. Optional Equipment: If used follow requirements

18.3.1. Spurs if worn must be English type

18.3.2. Crops, bats, or whips if used may be no longer than 30" including lash

18.4. Hunt Seat Trail

18.4.1. When an athlete is required to work a gate or carry a required object, the athlete is permitted to use one (1) hand on the reins without it being considered "illegal use of permitted equipment".

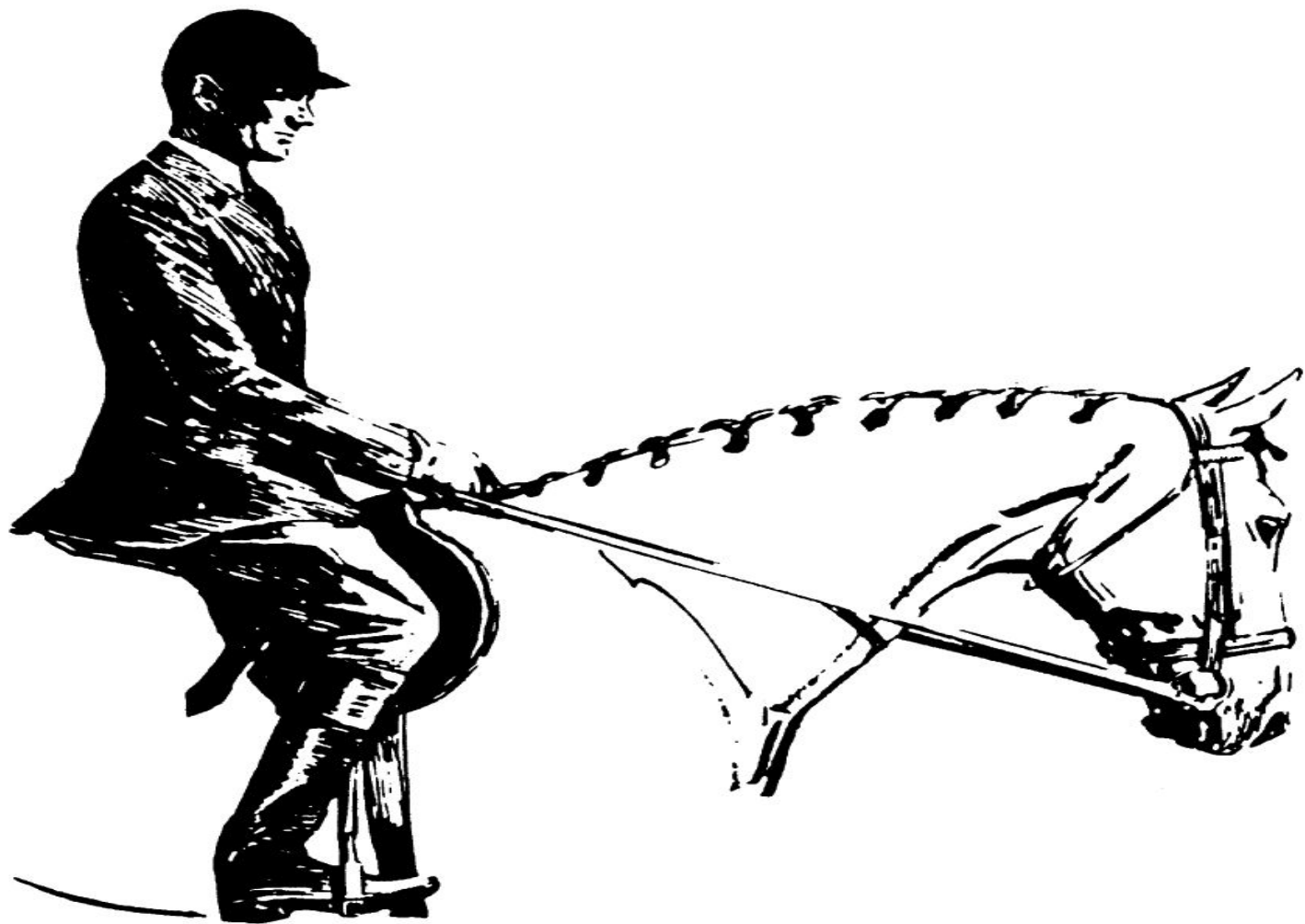

19. Hunt Seat Equitation Over Fences

Reference Rules USEF Chapter "EQ" & "HU"

19.1. Required Equipment

19.1.1. Saddle

19.1.1.1. Forward Seat Saddle

19.1.1.2. Multipurpose, English type saddle

19.1.2. Bits

19.1.2.1. Regulation snaffle

19.1.2.2. Pelham

19.1.2.3. Full Bridles

19.1.2.4. Kimberwicks

19.1.2.5. with Cavesson nose-bands

19.2. Prohibited Equipment:

19.2.1. Draw reins

19.2.2. Non-English type spurs

19.2.3. Prohibited Saddles

19.2.3.1. Western

19.2.3.2. Sidesaddles

19.2.3.3. Saddle seat style cutback saddle

19.2.3.4. Dressage saddle

19.2.4. Bit converters

19.2.5. Gag bit

19.2.6. Ribbon, glitter & sparkle (Exception: Residual from working pairs when scheduling does not allow its removal)

19.2.7. Side pulls

19.3. Optional Equipment: If used follow requirements

19.3.1. Crops, bats or whips if used may be no longer than 30" including lash

19.3.2. Martingales

19.3.2.1. Running martingales must have rein stops (Rubber or leather stops slipped onto the rein between the bit and the ring of the martingale).

19.4. Fences shall not exceed a maximum height or spread of 2 feet, ~~9 inches~~ **6 inches** (2'6")

19.5. A safety inspection of equipment, by the Judge, will be performed prior to event. Equipment checks are part of the score

19.5.1. Girth tight

19.5.2. Stirrup bars, if present, must be open

19.5.3. Proper adjustment of martingales

19.5.4. Condition of leather and stitching in girth and stirrup leathers

19.5.5. Helmet strap adjusted properly

19.6. Qualifying

19.6.1. The officiating judge shall determine if the athlete and/or equine are competent to ride the class

19.6.2. The judge may excuse any athlete deemed unsafe at any time on the course

19.6.3. Any athlete taking a fence other than those designated by the course and/or judge during the warm up may result in disqualification at the judges discretion.

19.6.4. The decision of the judge shall be final

19.7. Refusals

19.7.1. Mandatory score deductions will be made and noted on the score sheet in the space provided. Judges may also factor the refusal into their element score at their discretion.

19.7.1.1. 1st refusal shall incur a deduction of three (3) points

19.7.1.2. 2nd refusal shall incur a deduction of five (5) points for a total of eight (8) points

19.8. Elimination

19.8.1. Fall of equine and/or athlete

19.8.2. Off course

19.8.3. Three (3) combined refusals

19.8.3.1. Eliminated athletes will not be eligible for placing points

19.8.3.2. At the Judge's discretion, an eliminated athlete may jump an additional fence, but may not continue thereafter

19.8.4. During warm up, any athlete taking a course fence that has not been designated for warm up may be eliminated at the judges discretion.

20. In Hand Obstacle Relay (IHOR)

20.1. Required Equipment

20.1.1. Halter and lead rope or leather lead

20.2. Prohibited Equipment

20.2.1. Bridles of any type

20.2.2. Whips, crops, or bats

20.2.3. Spurs

20.2.4. Chaps/Chinks

20.3. This is a four (4) person team event

20.3.1. Schools with only two (2) or three (3) eligible competing athletes will be allowed to participate using four (4) different equine.

20.3.2. Athletes must be of the same discipline, including same color shirt, for uniformity. They must be all English or all Western.

20.3.2.1. Combo teams may compete in their respective school uniforms/color with their unique athlete number.

20.4. All in-hand and riding equine are eligible for this event.

20.5. Each athlete may earn up to ten (10) points each for navigating the mandatory obstacles.

20.5.1. Athletes will be judged on the performance of the handler and equine as they negotiate each obstacle.

20.5.2. Athletes will earn up to ten (10) points as a team for their showmanship and sportsmanship behind the line.

20.6. Gaits between obstacles are optional unless specified by the pattern.

20.7. Hand aids, without touching the equine should not expect a zero (0), but will be scored accordingly.

20.8. Each team member may earn up to an additional ten (10) points for the team by completing the bonus obstacle.

20.9. Event Procedure

20.9.1. All team members shall be positioned behind the 30' start/finish line in the arena.

20.9.2. Time starts when the first part of the handler/equine breaks the plane of the starting line

20.9.2.1. The line judge is permitted to use an electronic timer where time can be displayed for the athletes and spectators.

20.9.2.2. When an electronic timer is used, the line judge will use a hand-held stopwatch and record a backup overall time.

20.9.3. The next contestant cannot break the place of the start line until the contestant on course (handler) has crossed the start/finish line.

20.9.3.1. A scratch has occurred when two (2) handlers are determined to be on the course at the same time.

20.9.3.1.1. A team in violation will be given a ten (10) point penalty for each occurrence.

20.9.4. Time shall end when the last part of the fourth handler/equine crosses the start/finish line.

20.10. Each team is allowed five (5) minutes to complete the course.

20.10.1. Any teams exceeding the five (5) minute allotment shall be assessed a then (10) point penalty for each minute or fraction of a minute in violation.

20.10.1.1. 5:01 minutes - 6:00 minutes = -10 point penalty

20.10.1.2. 6:01 minutes - 7:00 minutes = -20 point penalty

20.10.2. Time will be reported to .01 only. Thousandths place, if generated, will be dropped with no rounding.

20.10.3. Teams will be signaled to stop after seven (7) minutes on the course

20.10.3.1. A thirty (30) second warning will be given

20.10.3.2. When time is called, the athlete on course will not continue

20.10.3.3. Teams will receive all scores to that point and will accrue appropriate time penalties.

20.11. Points will be added up for all mandatory and bonus obstacles for each contestant and added together with the other team members to determine total team score.

20.12. Penalty points will be deducted from the team's total to determine the final team score.

20.13. In the event of a point tie, time will be used as the tie breaker

20.14. Only an athlete currently on the course may re-set an obstacle during a team's go.

20.14.1. Arena crew will re-set the course between teams, but not between athletes on the same team.

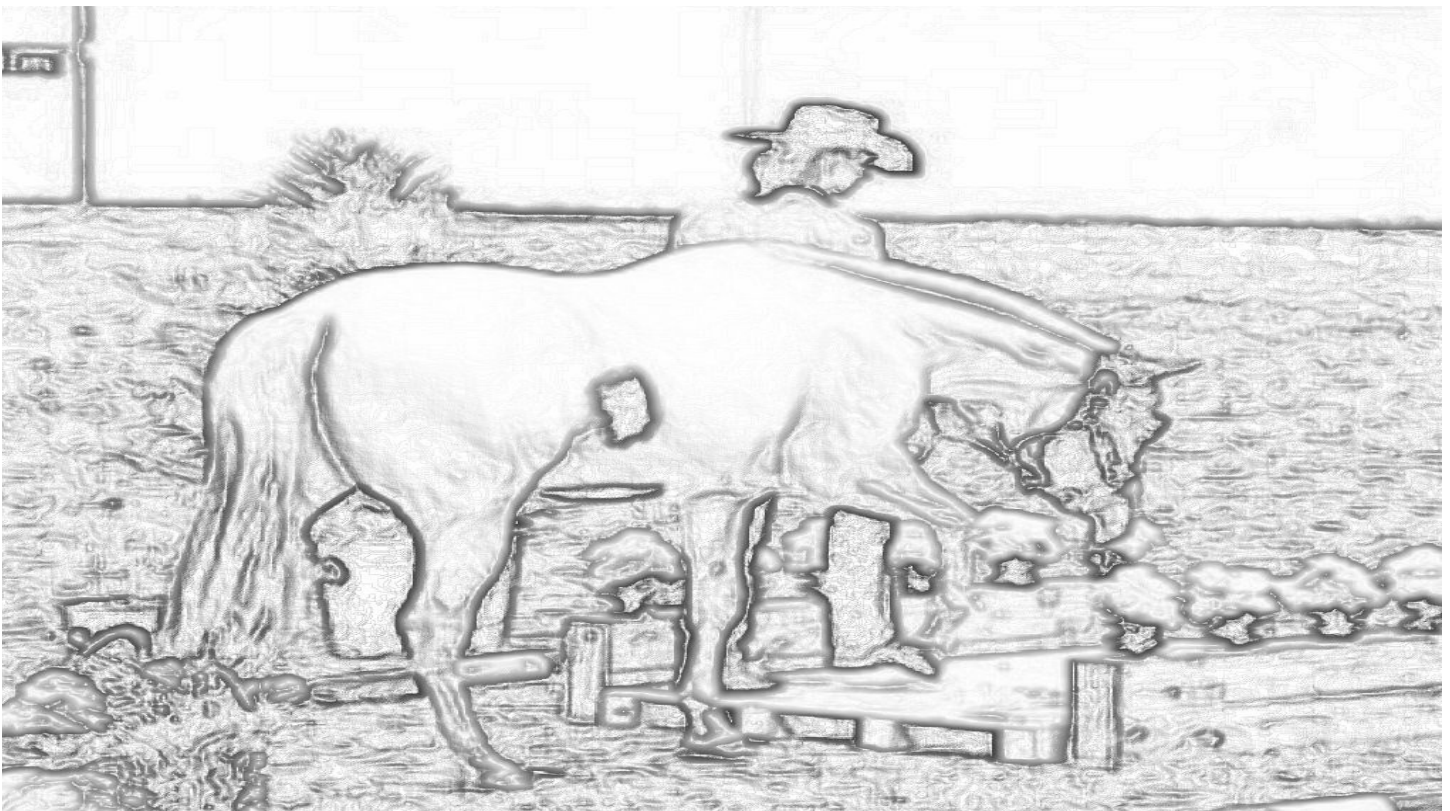

21. In-Hand Trail

21.1. Required Equipment

21.1.1. Halter and lead rope or leather lead

21.2. Prohibited Equipment

21.2.1. Bridles of any type

21.2.2. Whips, crops, or bats

21.2.3. Spurs

21.2.4. Chaps/Chinks

21.2.5. Leg Wraps//*Splint Boots/Protective Leg Gear*

21.2.6. Ribbons, glitter, and sparkle on equine

21.3. This class will use a regular trail course, with alterations to allow for animals to be shown in-hand.

21.4. To be judged the same as a trail course.

21.5. After two (2) refusals, the judge shall ask the athlete to move on to the next obstacle.

21.6. All obstacles (including bridges) are navigated by equine and handler.

21.7. Hand aids are allowed

21.7.1. Athletes may not touch equine unless directed by the judge or specified in the pattern.

21.7.2. Athletes touching their equine should not expect a zero (0), but will be scored accordingly.

21.8. In-hand trail equine is not restricted to size or breed.

22. Reining

Reference Rules USEF Chapter "RN"

22.1. Required Equipment

22.1.1. Western saddle with horn.

22.1.2. There shall be no discrimination against any standard western bit.

22.1.3. Chin/Curb straps

22.1.3.1. Chin/curb straps worn on a snaffle bit must be placed below the rein attachment

22.1.3.2. Chin/curb straps worn on a curb bit must be placed in the proper location for the specific bit.

22.1.4. Split reins, when used with a curb bit, must be held with one (1) finger between the reins with the bight of the rein falling on the same side as the rein hand. They may also be held like romal reins with all fingers wrapped around the reins and with the bight held in the opposite hand. There can be no fingers between the reins when held romal style.

22.2. Prohibited Equipment

22.2.1. Jerk lines

22.2.2. Tack collars

22.2.3. Chaps & 1/2 Chaps

22.2.4. Whips, crops, or bats

22.2.5. Slip or gag bits

22.2.6. Wire chin straps regardless of padding or covering

22.2.7. Any chin strap narrower than 1/2 inch

22.2.8. Martingales and draw reins

22.2.9. Sidesaddle or any type of English saddle

22.2.10. Nose-bands and tie-downs

22.2.11. Chinks

22.2.12. Roping reins

22.2.13. Snaffles or Bosals on equine six (6) years of age and older

22.2.13.1. Documentation of equines age may be requested

22.2.13.2. Junior equines are defined as equine five (5) years old and under

22.2.14. Side pulls

22.3. Optional equipment: if used must follow requirements

22.3.1. Rope or Riata must be coiled and securely attached to the saddle

22.4. Judging Point Deductions

22.4.1. During spins, over or under rotations greater than ninety (90) degrees will result in a zero (0) for that maneuver. Under or over rotations less than or equal to ninety (90) degrees will be scored based on the quality of the spin.

22.4.2. Lope out of rollback may be on either lead, but horse must be on correct lead prior to corner (with no break in stride) if continuing around end.

22.4.3. Any off course movements within an element will result in a score of a zero (0) for the entire element.

22.4.4. Flying lead changes are required and should be attempted. Horses attempting flying changes and not completing will be scored accordingly. Horses not attempting a flying change and performing other changes will be given a score of zero (0) for that element.



23. Saddle Seat Equitation, Saddle Seat Trail

Reference Rules USEF Chapter "EQ" - Sub-chapters: Eq-1 & Eq-3

23.1. Required Equipment

23.1.1. Cutback Saddle

23.1.2. Bridle, Bit

23.1.2.1. Full Bridle (curb and snaffle)

23.1.2.2. Pelham Bridle, single bit with two (2) sets of reins

23.1.2.3. Gaited horses may use breed specific bridles

23.1.2.3.1. Single curb bit with a single rein

23.2. Prohibited Equipment:

23.2.1. Draw reins

23.2.2. Non-English type spurs

23.2.3. Western dressage, hunt seat or sidesaddles

23.2.4. Bit converters

23.2.5. Gag bit

23.2.6. Ribbon, glitter & sparkle. Exception: Residual from Working Pairs when scheduling does not allow its removal.

23.2.7. Figure 8, flash, or dropped nose-band

23.2.8. Martingales

23.2.9. Protective boots, leg wraps, and bandages

23.2.10. Side pulls

23.3. Optional equipment: If used must follow requirements

23.3.1. Spurs if used are of an English type, blunt, unroweled

23.3.2. Crops, bats, or whips if used may be no longer than 44" including lash

23.3.3. Saddle Seat pants may have pin stripes

23.4. Saddle Seat Trail

23.4.1. When an athlete is required to work a gate or carry a required object, the athlete is permitted to use one (1) hand on the reins without it being considered "illegal use of permitted equipment"

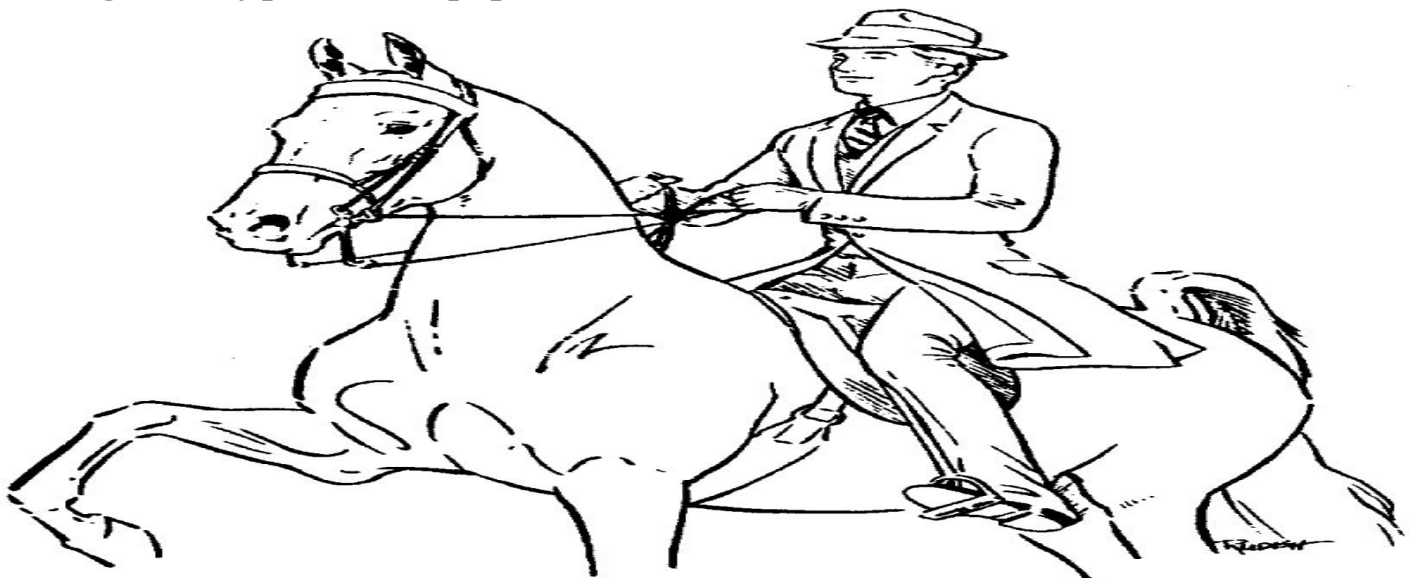

24. Showmanship

24.1. Required Equipment

24.1.1. Halter and lead rope or leather lead

24.1.2. Lead shall be six feet (6') - eight feet (8') in length

24.2. Prohibited Equipment

24.2.1. Bridles of any type

Exception: Bridles allowed if appropriate for breed specifications, and equine is shown according to breed rules

24.2.2. Whips, crops, or bats

24.2.3. Spurs

24.2.4. Chaps/Chinks

24.2.5. Leg Wraps

24.2.6. Ribbons, glitter, and sparkle on equine

24.3. Equine may be shown according to breed specifications, and may use a bridle if specified in breed rules.

24.4. Showmanship is a demonstration of the athlete's ability to show the equine to the best advantage in a halter. Confirmation is not to be considered.

24.5. Hand aids, without touching the equine, are allowed.

24.5.1. Athletes may touch the equine when directed by the judge or specified in the pattern

24.5.1.1. Athletes touching their equine should not expect a zero (0), but will be scored accordingly.

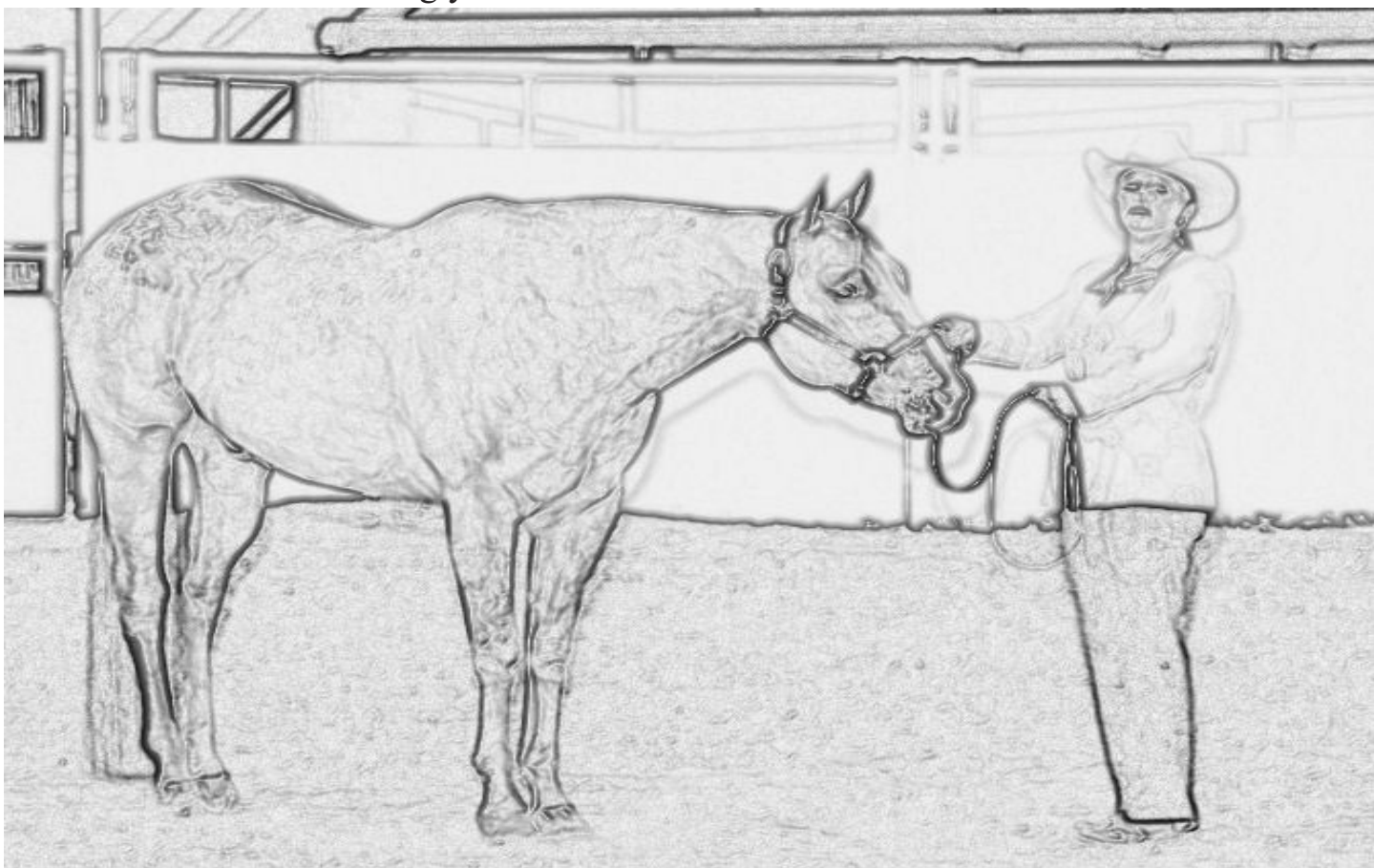

25. Timed Events, General Rules

25.1. Required Equipment

- 25.1.1. Western Bridle or Hackamore
- 25.1.2. Western type saddle with horn
- 25.1.3. Roping, Romal, or Mecate reins

25.2. Prohibited Equipment

- 25.2.1. Halters only
- 25.2.2. Split Reins
- 25.2.3. Chaps, 1/2 Chaps, or Chinks
- 25.2.4. Lariat Ropes

25.3. Optional Equipment: if used must follow requirements

- 25.3.1. Over and under subject to inspection by the judge
- 25.3.2. Tie-downs attached to or under breast collar and fitted properly subject to inspection by the judge
- 25.3.3. Martingales fitted properly and subject to inspection by the judge
 - 25.3.3.1. Rein stops are required on running martingales

25.4. Timing

- 25.4.1. An electronic-eye type timer will be used
 - 25.4.1.1. In the event of electronic eye type timer failure the event will pause until it can be fixed or replaced.
 - 25.4.1.2. All events will be measured and recorded to the thousandths place (16.010). Additional numbers beyond the thousandths place will be dropped, no rounding.

25.5. Setting and Re-Setting the course

- 25.5.1. It is the event judge's responsibility to oversee, supervise and participate in all course set up
- 25.5.2. In NO event will the course be reset during a team or individual run

25.6. Arena Safety

- 25.6.1. As soon as possible, after athlete enters the arena, all gates are to be closed and remain closed until athlete has completed their "run".
 - 25.6.1.1. Running in the gate is NOT allowed and will be considered an elimination/No Time
 - 25.6.1.2. Gate does not have to be closed for athlete to start
- 25.6.2. Only athletes on course, coaches, advisors, ring crew and officials are allowed in the arena during the event.

25.7. On Course

- 25.7.1. Starts when the athlete breaks the plane of the Start/Finish line
- 25.7.2. Ends when the athlete breaks the plane of the Start/Finish line

25.8. Re-rides

- 25.8.1. May be awarded at Judge's discretion including, but not limited to:
 - 25.8.1.1. In the event both official and the back-up timers fail

- 25.8.1.1.1. No penalties will be carried over
- 25.8.1.1.2. All new penalties will apply
- 25.8.1.2. Re-rides will be ridden at the bottom of the order for that event
- 25.8.1.3. Rider must request a re-ride immediately
- 25.9. Eliminations - Participation point awarded
 - 25.9.1. Running in the arena and onto the course
 - 25.9.2. Leaving the course, run outs, refusals, upsetting the starting poles
 - 25.9.3. Upsetting timer or start poles
 - 25.9.4. Failure to keep at least one (1) hand on the reins, except when momentarily dropping them.
 - 25.9.5. Taking more than thirty (30) seconds to cross the starting line
 - 25.9.5.1. The thirty (30) seconds starts after the announcer has announced the athlete and the judge raises their hand with a closed fist indicating the course is ready.
 - 25.9.5.2. The course is considered to be “ready” when the gate is open, the path through the gate is clean and the arena is clear.
 - 25.9.6. Fall of the rider while on course
 - 25.9.7. Dismounting at any time will on course (except in Team Canadian Flags)
 - 25.9.8. Loss of control or an unmanageable equine
 - 25.9.9. Athlete fails to enter and leave the arena demonstrating control
 - 25.9.10. Equine that constitute a safety hazard will be eliminated.
 - 25.9.11. Off Course
 - 25.9.11.1. Off course will be defined as:
 - 25.9.11.1.1. Not following the prescribed pattern.
 - 25.9.11.1.2. All four (4) feet past any obstacle on the wrong side (except Keyhole, where any part on the line or past the neck is a No Time).
 - 25.9.11.1.3. Circling any part of the course before crossing the start line
- 25.10. Disqualifications - No points awarded
 - 25.10.1. Intentionally striking the equine with arena equipment
 - 25.10.2. Abuse or inhumane treatment as determined by the judge
 - 25.10.3. Unsportsmanlike or disorderly conduct in the arena
 - 25.10.3.1. Including use of profane language
- 25.11. Course Records
 - 25.11.1. There are no ties; the record must be broken for it to be a new course record.
 - 25.11.2. The course will immediately be measured and may not be more than eight inches (8”) short in the overall length.
 - 25.11.2.1. In the Keyhole race, the course cannot be more than four inches (4”) over the correct width of the neck, or four inches (4”) shorter than the correct length of neck.
 - 25.11.3. The electronic time will be accepted as official as long as the manual time supports it.

- 25.11.3.1. At judge's and official timer's discretion
- 25.11.4. If the electronic time fails and the manual back-up time is a record the manual time may be used for class placing, but not as a "record". The athlete has the choice to:
 - 25.11.4.1. Use the manual time with no record receiving class placing based on manual time.
 - 25.11.4.2. The athlete may choose a re-ride
 - 25.11.4.2.1. If a re-ride is chosen, all re-ride rules apply
 - 25.11.4.2.2. Once the re-ride begins (the athlete attempts to enter the arena) that athlete is committed to using the re-ride time. They may no longer choose to take their original time.
- 25.11.5. The athlete holding the best time in the state for that event is deemed the state record holder, whether course is run at a district or State meet.
- 25.11.6. Records will be tracked for all events in each district and State championship.
 - 25.11.6.1. Each district will have a district record in all timed events. The district record shall be earned at a district meet.
 - 25.11.6.2. The State Championship will have a state championship record in all timed events. The state championship record shall be earned at a state championship meet.
- 25.11.7. Record is to be confirmed in writing by the official timer and the judge utilizing the timed event record form.
 - 25.11.7.1. This form should then be forwarded to the state points chair immediately following the meet.
 - 25.11.7.2. All timed event record forms should be sent in to the state points chair, even if the record is broken again during the same event.
- 25.11.8. When a new event is added follow this process for tracking records:
 - 25.11.8.1. Set the course before the class and double check the measurements.
 - 25.11.8.2. Half way through the event, stop and re-measure the course
 - 25.11.8.3. At the end of the event the athlete with the fastest time will be the district record holder.
 - 25.11.8.4. At the next meet return to the normal record breaking process
 - 25.11.8.5. In an event's first year only the following will qualify for the State Championship meet:
 - 25.11.8.5.1. Gold, silver, and bronze medal winners
 - 25.11.8.5.2. A minimum of three (3) and up to a maximum of 10% (rounded up) of the average number of individual team/competitors
 - 25.11.8.5.3. An athlete placing 1st, 2nd, or 3rd in two (2) of (3) three meets.
 - 25.11.8.5.4. The current district record holder for the new event.

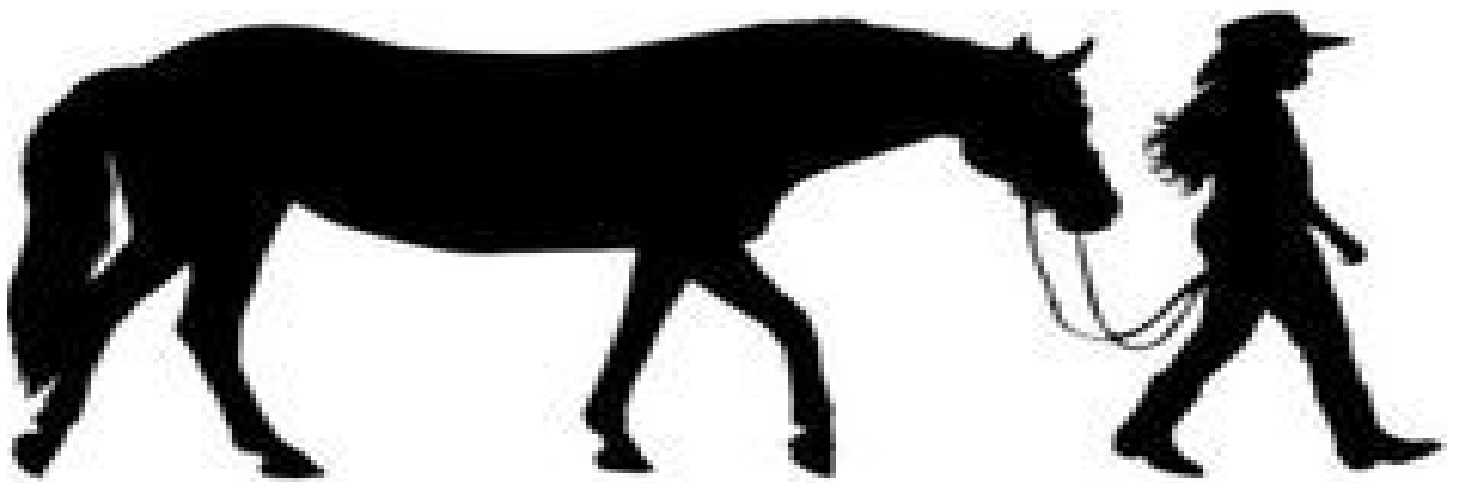

26. Barrels

26.1. Texas Barrels

26.1.1. Penalties

26.1.1.1. Knocking over any barrel is a five (5) second penalty

26.1.2. Equipment

26.1.2.1. Two (2) start poles/cones

26.1.2.2. Barrels

26.1.2.2.1. Plastic barrel with rimmed bottom thirty (30) and thirty-five (35) pounds

26.1.3. Set Up

26.1.3.1. There is a sixty foot (60') Start/Finish line

26.1.3.2. Three (3) barrels shall be placed in a triangular formation

26.1.3.3. Number 1 and number 2 barrels are set thirty-three feet (33') from the start/finish line and sixty feet (60') apart

26.1.3.4. Number 3 barrel is eighty feet (80') from Number 1 and Number 2 barrels (See Diagram)

26.1.4. Prescribed Pattern

26.1.4.1. Rider crosses starting line, circles right barrel to right or left barrel to left, then circles opposite barrel in opposite direction, then rides to middle barrel (3rd) and turns it the same direction as their second barrel, then races across finish line (See Diagram).

Left Barrel First

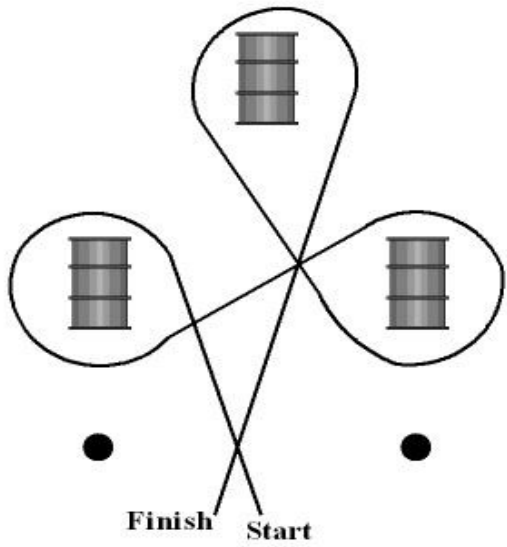

Right Barrel First

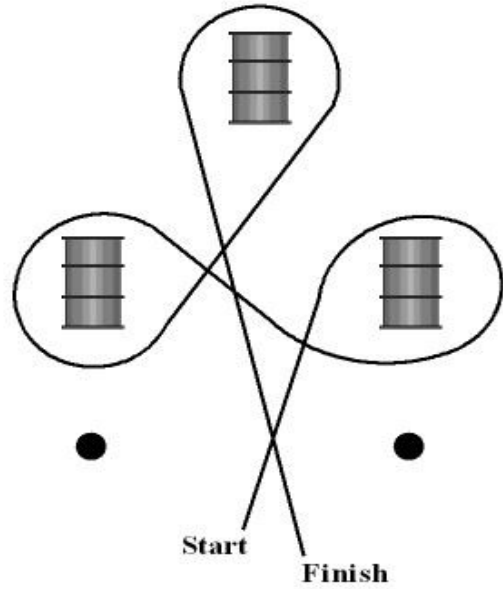

Dimensions

Note: Use chalk/flour/lime to mark measurements. Then place center of barrel directly on top of spot.

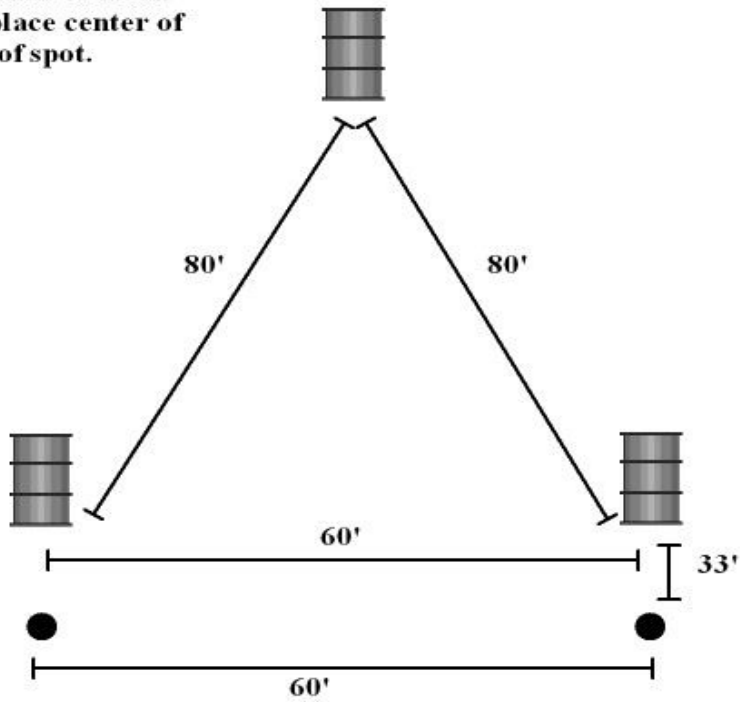

OHSET
Texas Barrels
Revised 11.4.11

27. Idaho Figure 8

27.1. Penalties

27.1.1. Knocking over either end pole is a five (5) second penalty

27.1.2. Idaho Figure 8 race athlete has only thirty (30) seconds to cross start/finish line from the time the course is ready or a no time will be issued.

27.2. Equipment

27.2.1. Four (4) poles with bases

27.2.1.1. Black rubber base, fourteen (14) pounds, six feet (6'') tall, fourteen feet (14'') across; total weight, pole and converter, approximately sixteen (16) pounds.

27.2.1.2. Poles to be white with two (2) three feet (3'') red or blue stripes. First is one (1) foot from the top and the 2nd one (1) foot down from the first stripe.

27.3. Set Up

27.3.1. Two (2) starting poles, thirty feet (30') apart

27.3.2. Two (2) poles set one hundred feet (100') apart at opposite ends of the course

27.3.3. The first pole will be set twenty feet (20') from the center of the start line

27.4. Prescribed Pattern

27.4.1. Athletes cross through the start poles traveling straight past the first pole and turn the top pole

27.4.2. Athletes then runs a figure 8 around the two (2) poles, one (1) to the left and one (1) to the right.

27.4.3. Athlete then runs down the side back through the start poles on the opposite side they started.

27.4.4. Athlete may choose either direction to turn first.

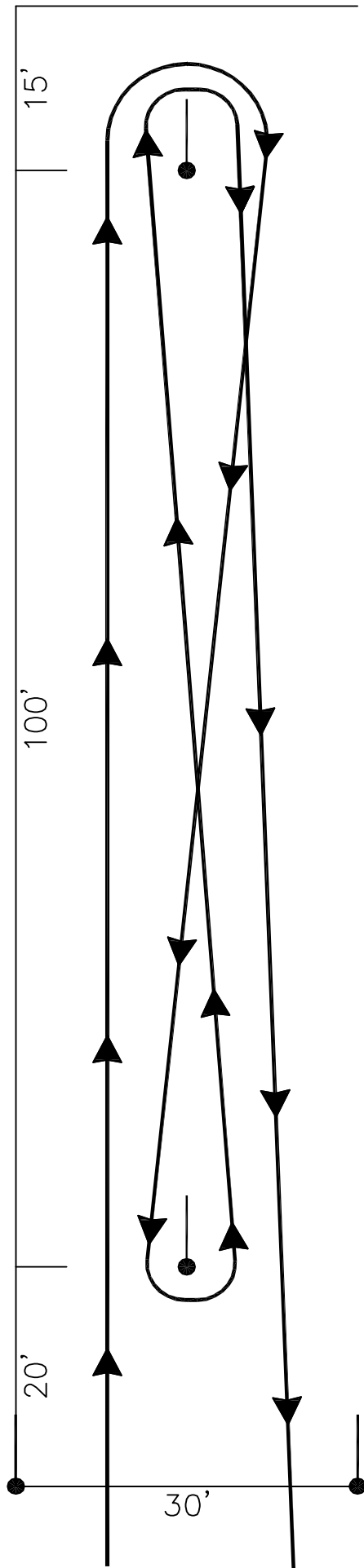
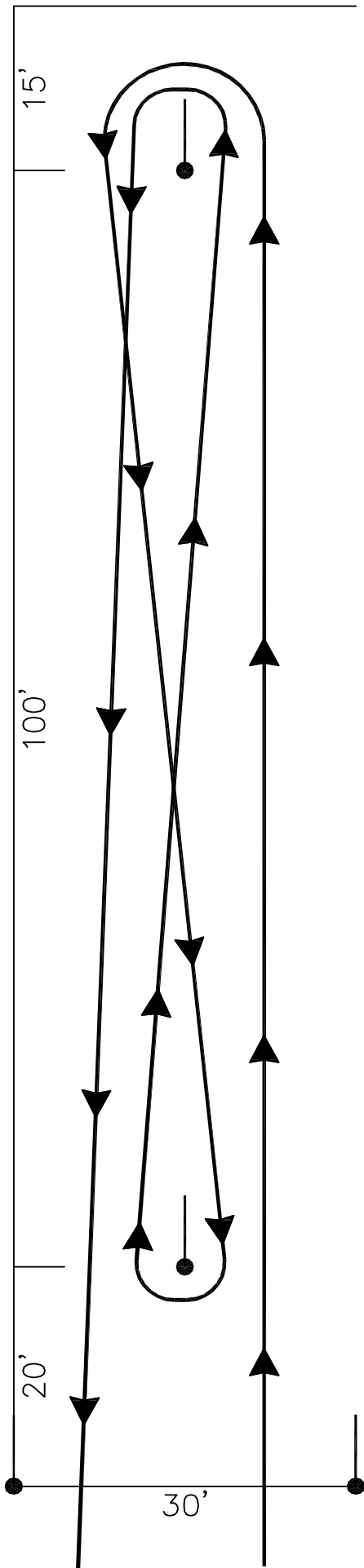

28. Individual Flags

28.1. Penalties

28.1.1. Failure to switch flags and place them in the appropriate cans, in the correct order, and go around second barrel will result in a penalty.

28.1.1.1. Flag (or flag ends of staff) must be in the correct cans when athlete crosses the finish line for no penalties.

28.1.1.2. A flag that falls out of the barrel after the athlete has crossed the finish line will not be penalized

28.1.1.3. A flag that misses the 3rd barrel (1st barrel), or is carried over the start/finish line will be a five (5) second penalty.

28.1.1.4. Failure to place the first flag in the second barrel will be an elimination.

28.2. Equipment

28.2.1. Two (2) start poles with bases

28.2.2. Two (2) 1/4 barrels (containers)

28.2.2.1. Painted white

28.2.3. Two Flags

28.2.3.1. One and one-sixteenth inch (1-1/6") diameter staff (doweling) - fir or hemlock

28.2.3.2. Five feet (5') long, painted white

28.2.3.3. Tapered at the bottom to a dull point

28.2.3.4. Flags to be sturdy cotton, double thickness, hemmed, eight inches by twelve inches (8"X12")

28.2.3.4.1. One (1) white and one (1) dark

28.2.3.4.2. Wrapped completely around the staff, leaving an eight inch by eight inch (8"X8") portion free from the staff

28.3. Set Up

28.3.1. Two (2) starting poles, thirty feet (30') apart

28.3.2. Two (2) containers placed one (1) hundred feet (100') apart at opposite ends of the course. First container is twenty (20') from the start line,

28.3.2.1. Each container will contain eight to ten inches (8'-10') of soil

28.4. Prescribed Pattern

28.4.1. Athlete crosses starting line, goes to first container taking that flag out

28.4.2. Then while going around the second barrel, exchanges the flags

28.4.3. Returns to the first container and places the flag from the second container into the first container

28.4.4. Then crosses the start/finish line

Begin on Left Side

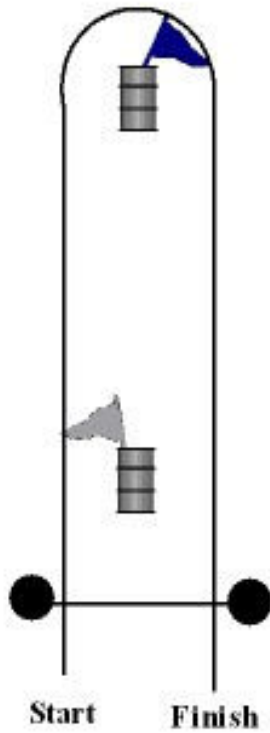

Begin on Right Side

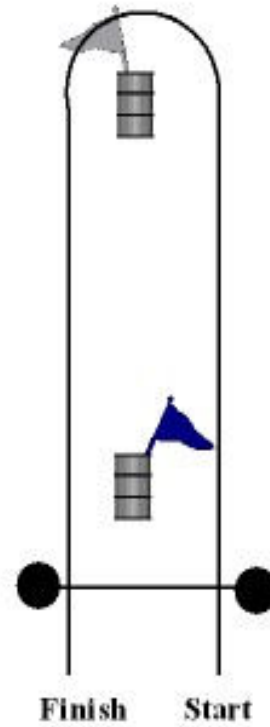

Dimensions

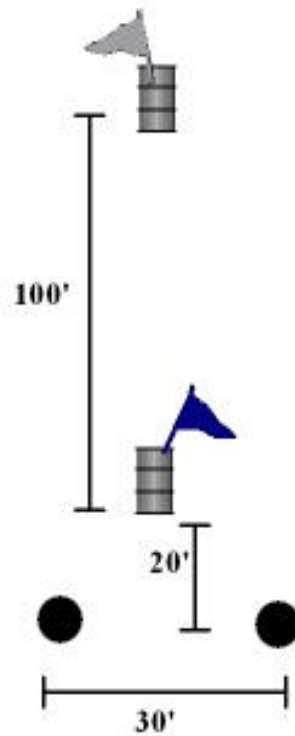

OHSET
Individual Flags
Revised 11.4.11

Note: Chalk, flour, or lime should be used to mark the spots when measuring. Center of barrels should be placed directly over spot.

29. Keyhole

29.1. Penalties

29.1.1. Stepping on, or outside any line of the keyhole is a no time

29.1.2. Any part of the hoof past the entrance of the key hole neck is a no time

29.1.2.1. This “neck” line continues across the arena

29.2. Equipment

29.2.1. Two (2) starting poles, thirty feet (30’) apart

29.2.2. A keyhole marked with lime (or similar substance)

29.3. Set Up

29.3.1. The neck of the keyhole begins eighty feet (80’) from start line in center of line
see diagram

29.3.1.1. The neck is five feet (5’) wide

29.3.1.2. The neck is ten feet (10’) long

29.3.2. Circle is twenty feet (20’) diameter

29.4. Prescribed Pattern

9.4.1. Athlete crosses the start/finish line, races into the circle of the keyhole
(completely clearing the neck with all four (4) hooves)

29.4.2. Turns horse one hundred eighty degrees (180) either direction

29.4.3. Run out and across the start/finish line

Note: Circle Diameter is 20'. Wings of chute are 2'.

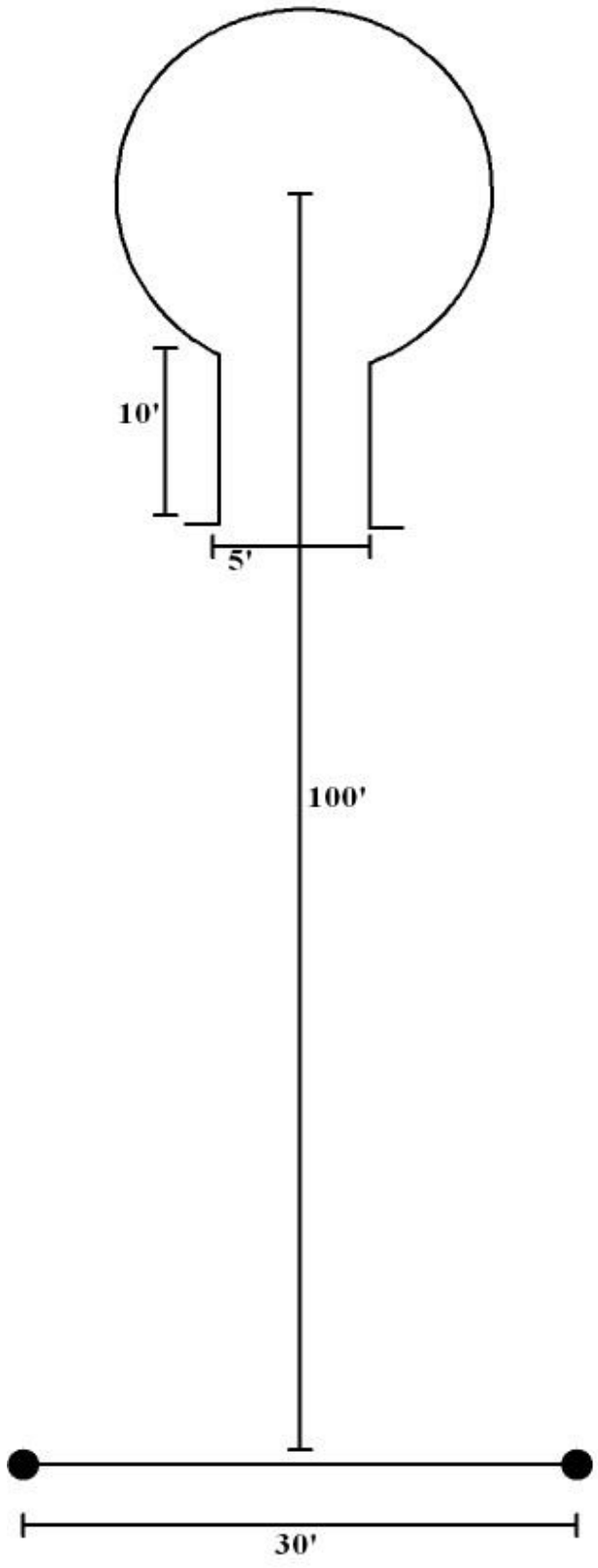

Note: may turn either direction in circle.

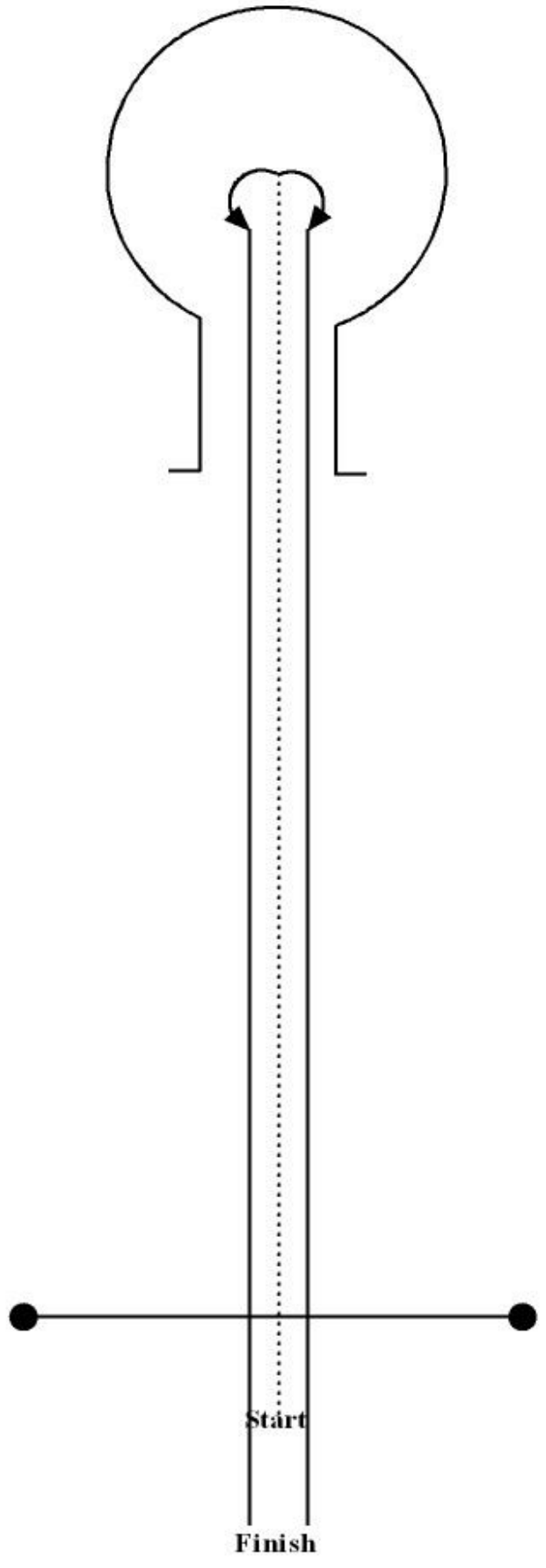

OHSET
KeyHole
Revised 11.4.11

30. Pole Bending

30.1. Penalties

30.1.1. Each pole knocked down is a five (5) second penalty

30.2. Equipment

30.2.1. Two (2) starting poles, thirty feet (30') apart

30.2.2. Six (6) additional poles with bases

30.2.2.1. Poles to be white, between one-inch and one-and-a-half-inch (1-1.5") PVC pipe

30.2.2.2. The same diameter of pole will be used for each event

30.2.2.3. Poles at the State Meet will be one-and-a-half-inch (1.5")

30.2.2.4. Schedule forty (4) or eighty (80)

30.2.2.5. Eighty to eighty one inches (80-81") long

30.2.2.6. With two (2) three-inch (3") red or blue stripes. First is one (1) foot from the top and the second one foot (1') down from the first tripe. (striping is optional)

30.2.3. Plastic converter (bushing) to be used to secure pole in base either by a cotter-key or glue

30.2.4. Black rubber base, fourteen (14) pounds, six inches (6') tall, fourteen inches (14") across;

30.2.5. Total weight, including base, pole and converter, approximately sixteen (16) pounds

30.3. Set Up

30.3.1. Six (6) poles shall be set in a straight line, beginning from the middle of the start poles, spaced twenty-one feet (21') apart with the start/finish line twenty-one feet (21') from the first pole

30.4. Prescribed Pattern

30.4.1. The athlete crosses the start/finish line, races to pole #6 (last pole in the line)

30.4.2. Then bends back through the poles

30.4.3. Completely turning pole #1 (closest to start poles)

30.4.4. Then bends back toward pole #6

30.4.5. Turns final pole and races straight across start/finish line

Begin on Left Side

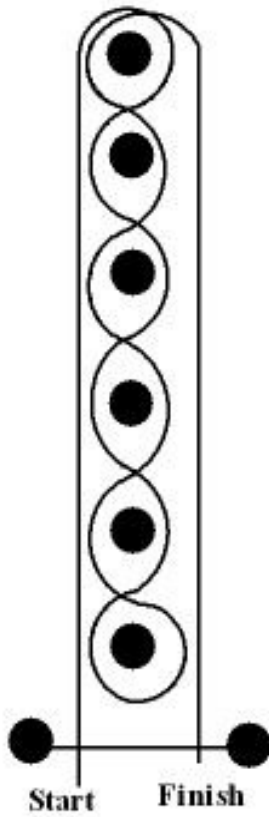

Begin on Right Side

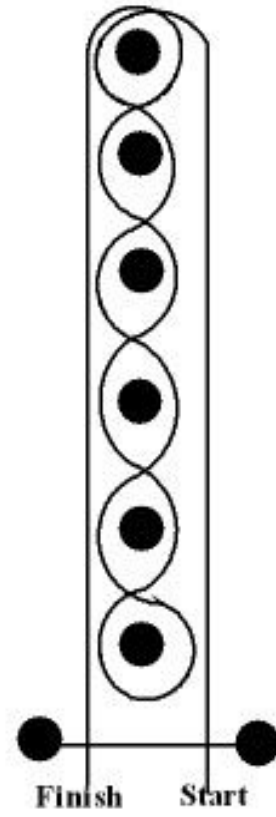

Dimensions

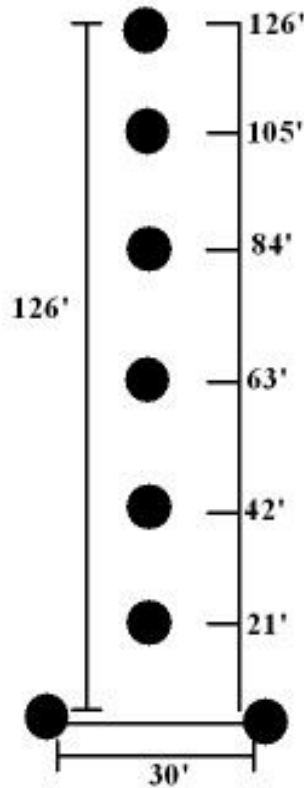

OHSET
Pole Bending
Revised 11.4.11

Note: Chalk, flour, or lime should be used to mark the spots when measuring. Center of Poles should be placed directly over spot.

31. Team Events (Timed)

31.1. Eliminations

31.1.1. Teams will be eliminated if any horse waiting its turn crosses the start/finish line before the horse on course crosses the start/finish line completely. There may not be two (2) horses on course at any time.

31.1.2. Unsafe Passing. Teams are encouraged to, but not required to pass (one coming off the course, one going on the course) on opposite ends of the start line. However, a pass deemed unsafe by the judge, may be cause for elimination.

31.2. Team Event Uniformity

31.2.1. Athletes from a school participating in a team event must be of the same discipline, including shirt color, for uniformity.

31.2.2. Combo teams may compete in their respective school uniforms/colors with their unique athlete number

32. Two Man Bi-Rangle

32.1. Penalties

32.1.1. Knocking over either pole is a five (5) second penalty

32.1.2. Equipment

32.1.2.1. Four (4) poles with bases

32.1.2.1.1. Black rubber base, fourteen pounds (14lbs), six inches (6") tall, fourteen inches (14") across; total weight, pole and converter, approximately sixteen pounds (16lbs).

32.1.2.1.2. Poles to be white with two (2) three inch (3") red or blue stripes. First is one foot (1') from the top and the 2nd one foot (1') down from the first stripe.

32.1.3. Set up

32.1.3.1. Two (2) start poles set thirty feet (30') apart

Removed: ~~***A center line will be identified at the start/finish line, approximately ten feet (10') long extending to the off course side and perpendicular to the start/finish line.***~~

32.1.3.2. Two (2) poles set thirty feet (30') apart, one hundred twenty feet (120') down the arena from start/finish line.

32.1.4. Prescribed Pattern

32.1.4.1. First athlete races down the course

32.1.4.2. Turns either pole from inside out,

32.1.4.3. Then turns the opposite pole from the outside in (either two (2) left or two (2) right turns)

32.1.4.4. Then races back across the start/finish line

32.1.4.5. Then the 2nd athlete runs the course,

32.1.4.5.1. They may turn either direction first - they do not need to turn the same direction as the first rider.

Right Turns

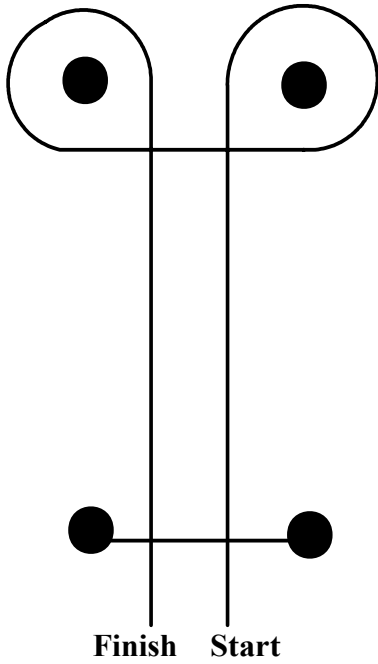

Left Turns

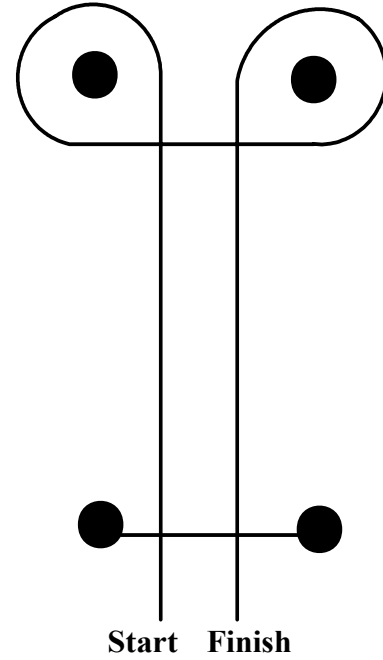

Dimensions

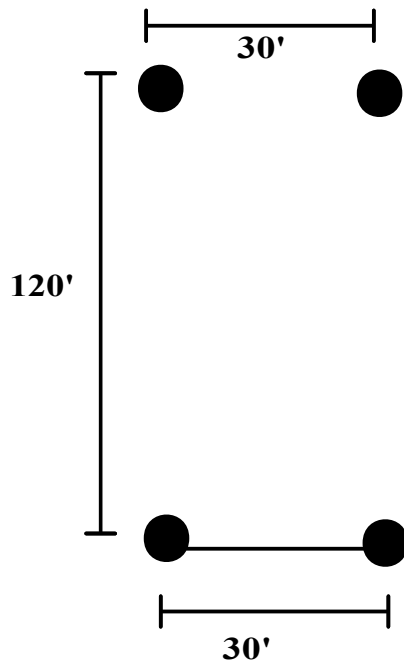

OHSET
Two Man Bi-Rangle
Revised 11.4.11

Note: Chalk, flour, or lime should be used to mark the spots when measuring. Center of Poles should be placed directly over spot.

33. Team Canadian Flags

33.1 This is a four (4) athlete team event

33.1.1. If a school has only three (3) riding athletes for the school they may ride this event with three (3) athletes, using four (4) equine.

33.1.2. The holder of the 4th equine should be a coach, advisor, or athlete in boots or hard-soled shoes.

33.2. Penalties

33.2.1. Failure to carry your flag over the start/finish line will result in an Elimination.

33.2.1.2. The equine and athlete must remain on the same side of the start/finish line while mounting and dismounting, moving or landing on the opposite side before completely being mounted will result in a “No Time”.

33.2.2. Not completely turning your flag (or the spot where it started) will result in a “No Time”.

33.3. Equipment

33.3.1. Two (2) start poles with bases

33.3.2. Four (4) forty-two inch (42”) staffs with small alternately colored flags (flags are required, color is optional)

33.3.2.1. Flag portion after being wrapped around staff will be eight inches by eight inches (8” x 8”).

33.4. Set Up

33.4.1. Two (2) start poles set thirty feet (30’) apart

Removed: ~~*A center line will be identified at the start/finish line, approximately ten feet (10’) long extending to the off-course side and perpendicular to the start/finish line.*~~

33.4.2. Four (4) flags shall be on the centerline of the course, with the first flag set one hundred feet (100’) from start/finish line, and the remainder of the flags set at two foot (2’) intervals. This means the fourth flag will be at one hundred six feet (106’) from the start/finish line.

33.5. Prescribed Pattern

33.5.1. First athlete races down the course and turns the last flag (farthest from the start/finish line) either direction picking up the last flag while turning and races back across the start/finish line carrying the flag.

33.5.2. Remaining riders follow the same action, each taking the farthest flag in line, until all riders have completed the course.

33.5.3. Any rider may turn either direction

33.5.4. Each rider must pick up their “assigned” flag in order

32.5.5. Any flag knocked over must be picked up by the corresponding rider during their turn

Right Turn

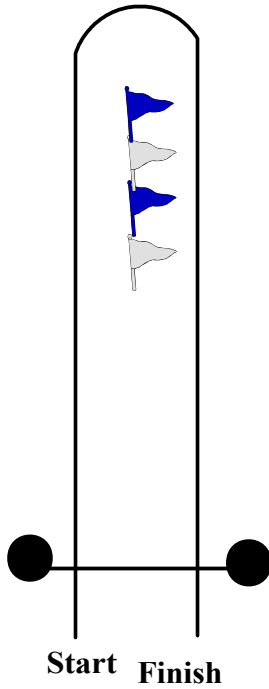

Left Turn

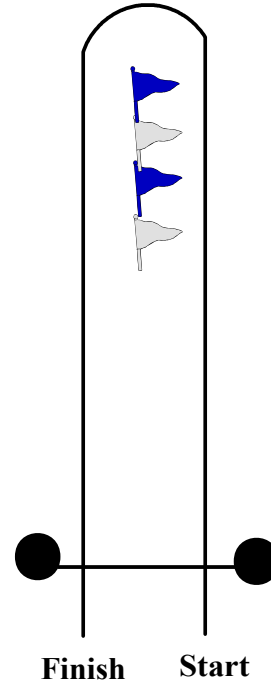

Dimensions

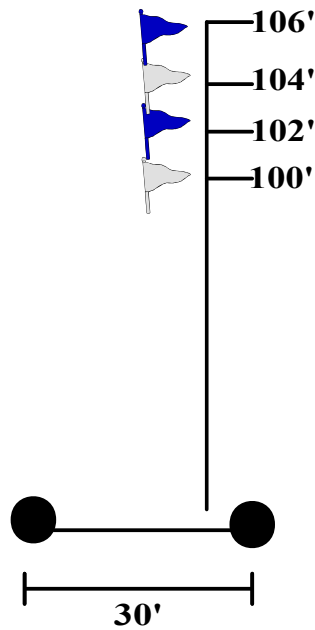

OHSET
Team Canadian Flags
Revised 11.4.11

Note: Chalk, flour, or lime should be used to mark the spots when measuring. Center of Poles should be placed directly over spot.

34. Team Versatility

34.1. All equipment, required/prohibited/optional, shall follow the rules of the specific discipline of each athlete. For example, the timed event rider will follow timed event rules for equipment. The equitation rider will follow the rules of whichever discipline they are riding in this event and so on.

34.1.1. Athlete attire must match their tack and equipment

34.1.2. Decoration of horses is allowed.

34.2. This is a four (4) person team event.

34.2.1. Schools with only two (2) eligible competing athletes will be allowed to participate using four (4) different equine.

34.3. There are four (4) disciplines and overall time in each course. One (1) athlete will represent each discipline. The final category is overall time.

34.3.1. When 34.2.1. is being followed; then one (1) athlete will compete in two (2) disciplines on two (2) different equine.

34.3.2. The disciplines will be done in the following order:

1) In Hand 2) Trail/Rancher 3) Equitation 4) Timed Event

34.3.3. In Hand: This part of the event the athlete may be attired in either English or Western and the athlete will always work with their equine from the ground. Elements of this part of the event will include anything you might find in one (1) of our In-Hand classes, including but not limited to: Walk/Trot overs, haunch and forehand turns, leading, backing, side-passing, etc.

34.3.4. Trail/Working Rancher: This part of the event might include any element you would find in a trail or working rancher event.

34.3.4.1. When a rope is required to be used in the element, the attire and equipment must follow required for Working Rancher.

34.3.4.2. When a rope is not required in the element the athlete may ride the course in one (1) of the following: Hunt Seat tack, Saddle Seat tack, Dressage tack, Western tack.

34.3.4.2.1. If Western tack is used for the element all attire considered legal for Western Trail and/or Working Rancher will be deemed legal.

Example: An athlete riding their equine in split reins and leg wraps is permitted.

Example: An athlete riding their equine in split reins and a nose-band with a tie-down strap attached to or run through the breast collar is permitted.

34.3.5. Equitation: This part of the event may best be ridden either Western or Hunt Seat Equitation, but if an element is appropriate, could also be ridden Saddle Seat equitation. Element might include any part of a typical Western or English equitation pattern.

34.3.6. Timed Event: This part of the event will be independently timed. This means every athlete should have an official time from the break of the start/finish line to the break of the start/finish line to the hundredth.

34.3.6.1. If two (2) teams have a tie for this element then it will be handled as all event ties are handled. For example: If two (2) athletes are tied for 3rd fastest time in the Timed Event element, each athlete's team will receive 3rd place points. The next athlete's team will be awarded 4th place points.

34.3.7. Overall time for each team is recorded to the hundredth (.01). Time is measured from the first break of the plane until the final equine/rider breaks the plane upon completion.

34.3.7.1. Overall times are then placed in order and awarded the following points as a scored element of the course.

34.3.7.1.1. First place receives ten (10) points

34.3.7.1.2. Second and third receive nine (9) points

34.3.7.1.3. Fourth and fifth receive eight (8) points

34.3.7.1.4. Sixth and seventh receive seven (7) points

34.3.7.1.5. Eighth receives six (6) points

34.3.7.1.6. Ninth receives five (5) points

34.3.7.1.7. Tenth receives four (4) points

34.3.7.1.8. All others with an overall time receive (2) points

34.3.7.2. If two (2) teams have a tie for overall time then it will be handled as all event ties are handled. For example: If two (2) teams are tied for 3rd place, each team will receive 3rd place points and the next team will be awarded 4th place points.

34.4. Event Set Up

34.4.1. The start/finish line will include three (3) poles ~~and two (2) cones~~

34.4.2. Timed event section must be at least twenty five feet (25') wide

34.4.3. Electronic timers are to be used at the timed event poles on the start line.

34.4.4. There will be a designated "stop box" for the timed event riders, it should be at least thirty feet by twenty-five feet (30' X 25'), but can be as large as possible, leaving room for the other three (3) horses to safely wait for completion of the run.

~~33.4.5. Area between timed event "inside" pole and cones may be disbursed appropriate to elements drawn for the event. See diagram~~

34.5. Event Procedure

34.5.1. Several maneuver options for each discipline will be supplied with patterns annually.

34.5.2. All teams perform the same maneuvers

34.5.3. Draw for maneuver may be used only once per season

34.5.3.1. Each maneuver may be used only once per season.

34.5.3.2. These four (4) maneuvers (1 in each discipline) make up the course.

34.5.4. All team members will enter at the same time and be positioned behind the start/finish line.

34.5.4.1. The first athlete will break the plane of the start line on to the course, the next athlete may not break the plane of the start line until the athlete on

course returns and is completely over the line.

34.5.4.2. This process continues until all four (4) disciplines are completed.

34.5.4.3. The timed event rider must stop completely (not still, just controlled and a clear halt) in the “stop box” before returning to the other athletes on the team and/or exiting.

34.5.4.4. Two (2) official times are required

34.5.4.4.1. These may be manual, electronic, or a combination of timers.

34.5.4.4.2. The overall time, from first athlete breaking the plane until last athlete breaks the plane upon finishing. This time will be used as an element of scoring.

34.5.4.4.3. The timed event athlete must be timed independently for their run.

34.6. Scoring

34.6.1. Each performance element is given a score of zero (0) to ten (10), ten (10) being perfect; score definitions mimic other scores throughout OHSET.

34.6.2. The timed event independent time is recorded on the score sheet

34.6.2.1. Later in the office, this time is compared to others from the meet and placed in order with the other athletes from the same meet.

34.6.2.1.1. Those athletes will be awarded points to add to their team’s overall scores on the following basis:

34.6.2.1.1.1. First place receives ten (10) points

34.6.2.1.1.2. Second and third receive nine (9) points

34.6.2.1.1.3. Fourth and fifth receive eight (8) points

34.6.2.1.1.4. Sixth and seventh receive seven (7) points

34.6.2.1.1.5. Eighth receives six (6) points

34.6.2.1.1.6. Ninth receives five (5) points

34.6.2.1.1.7. Tenth receives four (4) points

34.6.2.1.1.8. All others receiving a time receive two (2) points

34.6.2.1.1.9. No Time receives one (1) point

34.6.2.1.1.10. A DQ receives zero (0) points for the team.

34.6.3. Penalties may be assessed for the following:

34.6.3.1. Two (2) on the line receive a ten (10) point deduction for every occurrence

34.6.3.2. Up to ten (10) points can be deducted for unsafe behavior behind the line, this is at the discretion of the judge.

34.6.3.3. A five (5) second penalty will be assessed for every timed event knock down, missed flag, etc. Assessed utilizing the same guidelines as other timed event rules.

34.6.3.4. Timed event riders not stopping within the designated stop box will receive a No Time.

34.6.3.5. Timed event riders not stopping within the designated stop box and

proceeding toward the other horses in the area in an unsafe manner, based on judges' discretion may be disqualified.

34.6.3.6. All disqualification rules from performance and timed events apply.

34.6.3.6.1. Any athlete disqualified, disqualifies the team.

34.7. Judging: This event should include two (2) OHSET judges, an official judge and an official timer; this will depend on arena set up and the abilities of the judging team/district leadership. Judges can be timers in most cases, but timers should never be expected to be judges.

34.7.1. At the State Meet, three (3) judges, one (1) official timer, and one (1) timed event timer will officiate.

34.7.1.1. Official judge will judge each discipline, including timing the "Timed Event"

34.7.1.2. Official timer will manage overall time and watch for "behind the line" deductions

34.7.1.2.1. If these duties are split up differently because of expertise, that is acceptable

Elements set up down the arena in this space depending on the element. Each element includes set up directions if required.

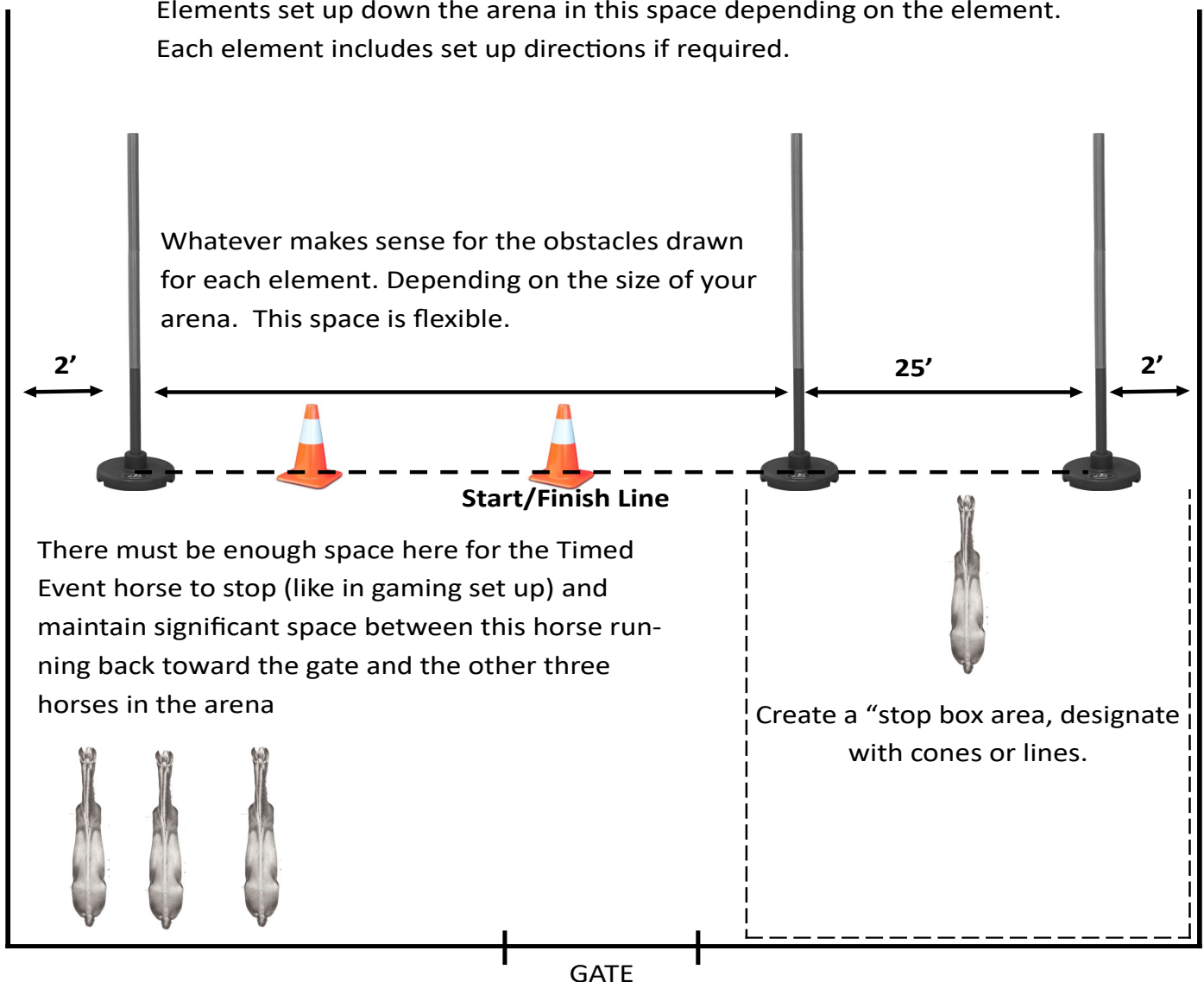

35. Western Horsemanship, Western Trail

Reference Rules USEF Chapter “EQ” and “WS”

35.1. Required Equipment

35.1.1. Western saddle with horn

35.1.1.1. There shall be no discrimination against any standard western bit. See USEF “WS” rules for more information on legal western bits.

35.1.1.2. Split reins, when used with a curb bit, must be held with one (1) finger between the reins with the bight of the rein falling on the same side as the rein hand. They may also be held like romal reins with all fingers wrapped around the reins and with the bight held in the opposite hand. There can be no fingers between the reins when held romal style.

35.1.2. Snaffle bits and rawhide bosal may only be used on junior equine

35.1.3. Chin/Curb straps

35.1.3.1. Chin/Curb straps worn on a snaffle bit must be placed below the rein attachment

35.1.3.2. Chin/Curb straps worn on a curb bit must be placed in the proper location for the specific bit

35.2. Prohibited Equipment

35.2.1. Jerk lines

35.2.2. Tack collars

35.2.3. Chaps & 1/2 Chaps

35.2.4. Whips, Crops or Bats

35.2.5. Slip or gag bits

35.2.6. Wire chin straps regardless of padding or covering

35.2.7. Any chin/curb strap narrower than half (1/2) inch

35.2.8. Martingales and draw reins

35.2.9. Sidesaddle or any type of English saddle

35.2.10. Nose bands and tie-downs

35.2.11. Chinks

35.2.12. Protective boots, leg wraps, and bandages

35.2.13. Roping reins

35.2.14. Snaffle or bosal on equine six (6) years of age or older

35.2.14.1. Documentation of equines age may be requested

35.2.14.2. Junior equines are defined as equines five (5) years old and under

35.2.15. Side pulls

35.3. Optional Equipment: if used must follow requirements

35.3.1. If rope or riata is carried it must be coiled and securely attached to the saddle.

35.3.2. Spurs, if used, must be Western

35.4. Disqualifications (Also see General Rules)

35.4.1. An athlete using two (2) hands on a curb bit, or one (1) hand on a snaffle bit is considered to be using permitted equipment illegally

35.4.1.1. When an equine is ridden in a snaffle bit or rawhide bosal, the athlete is permitted to use one (1) hand on the reins while working the gate, carrying a required object, or handling a rope without it being considered “illegal use of permitted equipment”.

35.4.1.2. If the athlete enters the arena and begins the pattern correctly holding the reins, they will not be disqualified but will receive a zero (0) on every element ridden illegally.



36. Working Pairs

36.1. Required Equipment

36.1.1. English or Western saddles and bridles

36.1.1.1. Both athletes must ride with the same type of equipment

36.1.1.2. Mixing English bridles with Western saddles, or Western bridles with English saddles is prohibited.

36.1.1.3. *Chin/curb straps*

36.1.1.3.1. Chin/curb straps worn on a snaffle bit must be placed below the rein attachment

36.1.1.3.2. Chin/curb straps worn on a curb/gag bit must be placed in the proper location for the specific bit.

36.1.2. Working Pairs is to be ridden in an arena close in size to a small Dressage court (65' X 130') without any type of borders using Dressage letters for orientation

36.2. Prohibited Equipment

36.2.1. Wire chin straps, regardless of how padded or covered

36.2.2. Any chin/curb strap narrower than half (1/2) inch

36.2.3. Draw reins

36.2.4. Jerk lines

36.2.5. Tack collars

36.2.6. Western chaps, chinks

36.2.7. Skirts (Sidesaddle)

36.2.8. Bit converters

36.2.9. Side pulls

36.2.10. Any costume element that is carried in the hand(s) including flags

36.2.11. Driving equipment

36.3. Optional Equipment: if used must follow requirements

36.3.1. All humane bits regardless of horses' age

36.3.2. Western curb bits may be ridden with two (2) hands

36.3.2.1. One (1) hand on a curb will score higher under degree of difficulty on the score sheet

36.3.3. Rope or riata if used must be coiled and securely attached to the saddle

36.3.4. If nose-bands and/or tie-downs are used they must be attached to or under the breast collar

36.3.5. Martingales

36.3.5.1. Running martingales must have rubber or leather stops slipped onto the rein between the bit and the ring of the martingale

36.4. Any age equine may use a snaffle in English or Western tack

36.5. Bosal or mechanical hackamore may be used with Western tack

36.6. Costumes allowed on equine only

36.6.1. No part of the costume may be on or held by the athlete

36.6.1.1. Decorated reins may be used. Decorations on reins cannot interfere with control and must be safe and effective

36.6.2. Any costume deemed unsafe by the judge will result in an elimination

36.7. Readers will not be allowed.

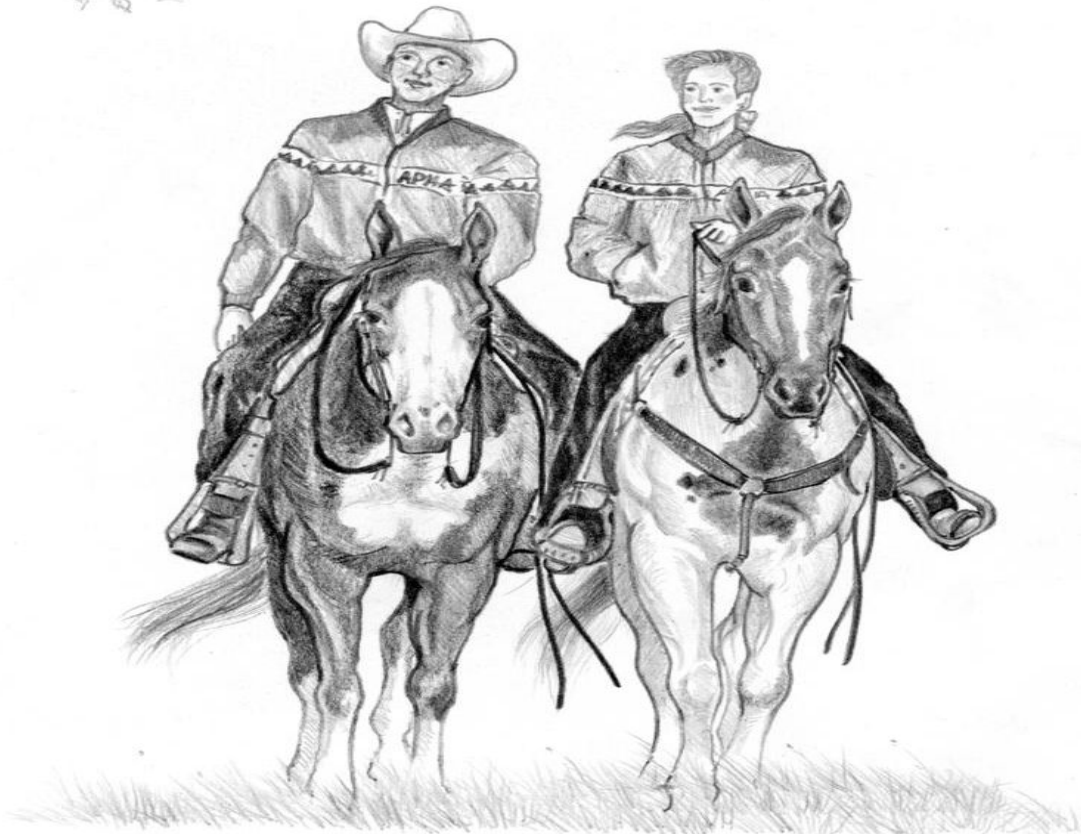

37. Working Rancher

37.1. Required Equipment

37.1.1. Western saddle with horn

37.1.2. There shall be no discrimination against any standard Western bit

37.1.3. All snaffle bits and rawhide bosals may only be used on junior equine

37.1.3.1. When an equine ridden in a snaffle bit or rawhide bosal, the athlete is permitted to use one (1) hand on the reins while working the gate, carrying a required obstacle, or handling a rope without it being considered “illegal use of permitted equipment”.

37.1.4. Chin/Curb Straps

37.1.4.1. Chin/Curb straps worn on a snaffle bit must be placed below the rein attachment

37.1.4.2. Chin/Curb straps worn on a curb bit must be placed in the proper location for the specific bit.

37.1.5. Roping, Romal, or Mecate reins

37.1.6. Rope

37.2. Prohibited Equipment

37.2.1. Jerk lines

37.2.2. Tack collars

37.2.3. Chaps & 1/2 Chaps

37.2.4. Whips, Crops, or bats

37.2.5. Slip or gag bits

37.2.6. Wire chin/curb strap regardless of padding or covering

37.2.7. Any chin/curb strap narrower than half (1/2) inch

37.2.8. Martingales and draw reins

37.2.9. Sidesaddle or any type of English saddle

37.2.10. Snaffles or bosals on equine six (6) years of age or older

37.2.10.1. Documentation of equines age may be requested

37.2.10.2. Junior equines are defines as equines five (5) years old and under

37.2.11. Side pulls

37.2.12. Split reins

37.2.13. Nose-bands and Cavesson of any type when not used with an attached tie down.

37.2.14. Mechanical Hackamore

37.3. Optional Equipment

37.3.1. Nose-bands with tie downs must be secured to or behind a breast collar